

CLASSICflo Balanced Flue range Gas fired storage water heaters for natural gas

Models RSC 9/145 and RSC 9/180
Auto Ignition



Please read and understand these instructions before commencing installation and leave this manual with the customer for future reference.

Andrews. Built to perform.



Reproduction of any information in this publication by any method is not permitted unless prior written approval has been obtained from Andrews Water Heaters.

Andrews Storage Water Heaters have been designed and manufactured to comply with current international standards of safety. In the interests of the health and safety of personnel and the continued safe, reliable operation of the equipment, safe working practices must be employed at all times. The attention of UK users is drawn to their responsibilities under the Health and Safety Regulations 1993.

All installation and service on Andrews Water Heaters must be carried out by properly qualified personnel and, therefore, no liability can be accepted for any damage or malfunction caused as a result of intervention by unauthorised personnel.

Andrews Water Heaters' policy is one of continuous product improvement and, therefore, the information in this manual, whilst completely up to date at the time of publication, may be subject to revision without prior notice.

Further information and assistance can be obtained from:

Customer support

Monday - Friday

8am - 5pm

Sales: 0345 070 1055

Technical: 0345 070 1057

Email: commercial@baxiheating.co.uk

Website: www.andrewswaterheaters.co.uk

Twitter: @andrewsWH



Note

The Andrews Water Heaters covered in this manual are for use with natural gas and LPG only

Copyright Andrews Water Heaters 2018

Contents

Andrews. Built to perform.	1
1.1 General Information	4
1.2 British Standards and Codes of Practice	4
1.3 Health and Safety Regulations 1993	5
1.4 Effectiveness in Combating Legionella	5
2 Technical Data	6
2.3 ErP data	9
3.2 Location	10
3.3 Flue System	10
3.4 Flue Fitting Instructions	12
3.5 Air Supply	13
3.6 Important	14
3.7 Water Quality and Treatment	15
3.8 Water Connections - General	16
3.9 Gas Connections	19
3.10 Electrical Supply	19
3.11 Wiring Diagram	20
4 Commissioning	21
4.1 20/190	21
4.2 Users Safety Guide	22
5 Operation	23
5.1 Burner Assembly	23
5.2 Burner flame check	24
5.4 Temperature selection procedure	25
6.1 Introduction	30
6.2 Burner Assembly	32
6.3 Gas Control Valve	33
6.4 Magnesium Anode	34
6.5 Descaling Information	34
6.6 Accessing service mode on the water heater display (Service personnel only)	35
6.7 How to reset the control from Lockout conditions	44
6.8 Diagnostic error codes and troubleshooting procedures for Honeywell integrated	47
7 Fault Finding	49
7.1 Andrews 20/190	49
8 Parts List	50
8.1 General Assembly	50
8.2 Control Box Assembly	52
8.3 General Assembly Parts List	53
9 Appendix	55
9.1 Dismantling, Disposal and Recycling	55
© Copyright	55

1 General and Safety Information

1.1 General Information

The Andrews Water Heater has been designed for use with NATURAL GAS & LPG only and is manufactured to give an efficient, reliable and long service life.

To ensure the continued, trouble-free operation of your heater at maximum efficiency, it is essential that correct installation, commissioning, operation and service procedures are carried out strictly in accordance with the instructions given in this manual. By law, installation and commissioning of the heater must be carried out by properly qualified personnel.

The heater(s) must be installed in accordance with the following requirements;

The current GAS SAFETY (INSTALLATION AND USE) REGULATIONS

The current BUILDING REGULATIONS

The Water Supply (WATER FITTINGS) REGULATIONS 1999

Additionally, installation should be performed in accordance with all relevant requirements of the Gas Supplier, Local Authority and recommendations of the British Standards and Codes of Practice detailed below.

1.2 British Standards and Codes of Practice

1.2.1 CLASSICflo Balanced Flue

BS 6700:	Specification for design, installation, testing and maintenance of services supplying water for domestic use within buildings and their curtilages. This standard supersedes the following British Standards and Codes of Practice: CP99, CP310, CP324, 202, CP342 Part 2, Centralised Hot Water Supply.
BS 5440:	Installation of flues and ventilation for gas appliances of rated output not exceeding 60kW.
Part 1:	Specification for installation of flues.
Part 2:	Specification for installation of ventilation for gas appliances.
BS 5546:	Installation of gas hot water supplies for domestic purposes.
BS 6891:	Installation of low pressure gas pipework of up to 28mm in domestic premises.
BS 7206:	Specification for unvented hot water storage units and packages.
BS EN 806	(Parts 1 - 5) Specifications for installations inside buildings conveying water for human consumption.
BS 6644	Installation of gas fired water boilers of rated inputs between 70kW and 1.8MW.
BS EN 12897	Water supply. Specification for indirectly heated unvented (closed) storage water heaters.
IGE/UP/1A,1B	Strength/tightness testing and direct purging.
IGE/UP/2	Installation pipework.
IGE/UP/10 - 1	(Edition 4): Installation of gas appliances in industrial and commercial premises.

i **Note**
Consideration should be given to amendments or updates to the above standards.

1.3 Health and Safety Regulations 1993

It is the duty of manufacturers and suppliers of products for use at work to ensure, so far as is practicable, that such products are safe and without risk to health when properly used and to make available to users, adequate information about their safe and proper operation.

Andrews Water Heaters should only be used in the manner and purpose for which they were intended and in accordance with the instructions in this manual. Although the heaters have been manufactured with paramount consideration to safety, certain basic precautions specified in this manual must be taken by the user.

It is imperative that all users of the heater must be provided with all the information and instruction necessary to ensure correct and safe operation.

1.4 Effectiveness in Combating Legionella

Water systems in buildings have been associated with outbreaks of Legionnaires' Disease, particularly in health care facilities where occupants are significantly more susceptible to infection.

In recognition of the risks in hospitals, a Code of Practice for the Control of Legionella in Health Care premises has been issued by the Department of Health (1991). Codes of Practice applicable to other premises have been published by other organisations, principally the Health and Safety Executive (HS)(G70) and the Chartered Institute of Building Services Engineers (CIBSE, TM13).

All Codes of Practice draw attention to the design and operation of water systems with reference to avoidance of factors that favour colonisation by legionella bacteria. These factors include stagnation, lukewarm conditions (20°C to 45°C) and the accumulation of debris, scale and corrosion in the base of tanks and calorifiers.

Andrews Water Heaters has commissioned an independent evaluation of their products to investigate their resistance to build-up of legionella bacteria.

Experiments were conducted to determine whether, following a substantial challenge by legionella pneumophila, after overnight and stagnation conditions, the system was rendered free from viable recoverable legionella. It was found that at 61°C, following a challenge of approximately 107 organisms per litre, within one hour, more than 99.999% of organisms had been killed. After a subsequent stagnation period, sampling did not reveal any residual contamination. The design of the base of the water heater precludes legionella colonisation, even after build-up of debris. The burner positioning ensures that the water at the bottom of the heater reaches the same, or higher temperature as in the rest of the heater.

Based on data obtained through experiment, the Andrews Water Heater can be described as legionella resistant as it is considered unlikely that, at the temperature tested, the organism would colonise the water heater and present a possible health risk.

2 Technical Data

2.1 Appliance Dimensions

Fig.1

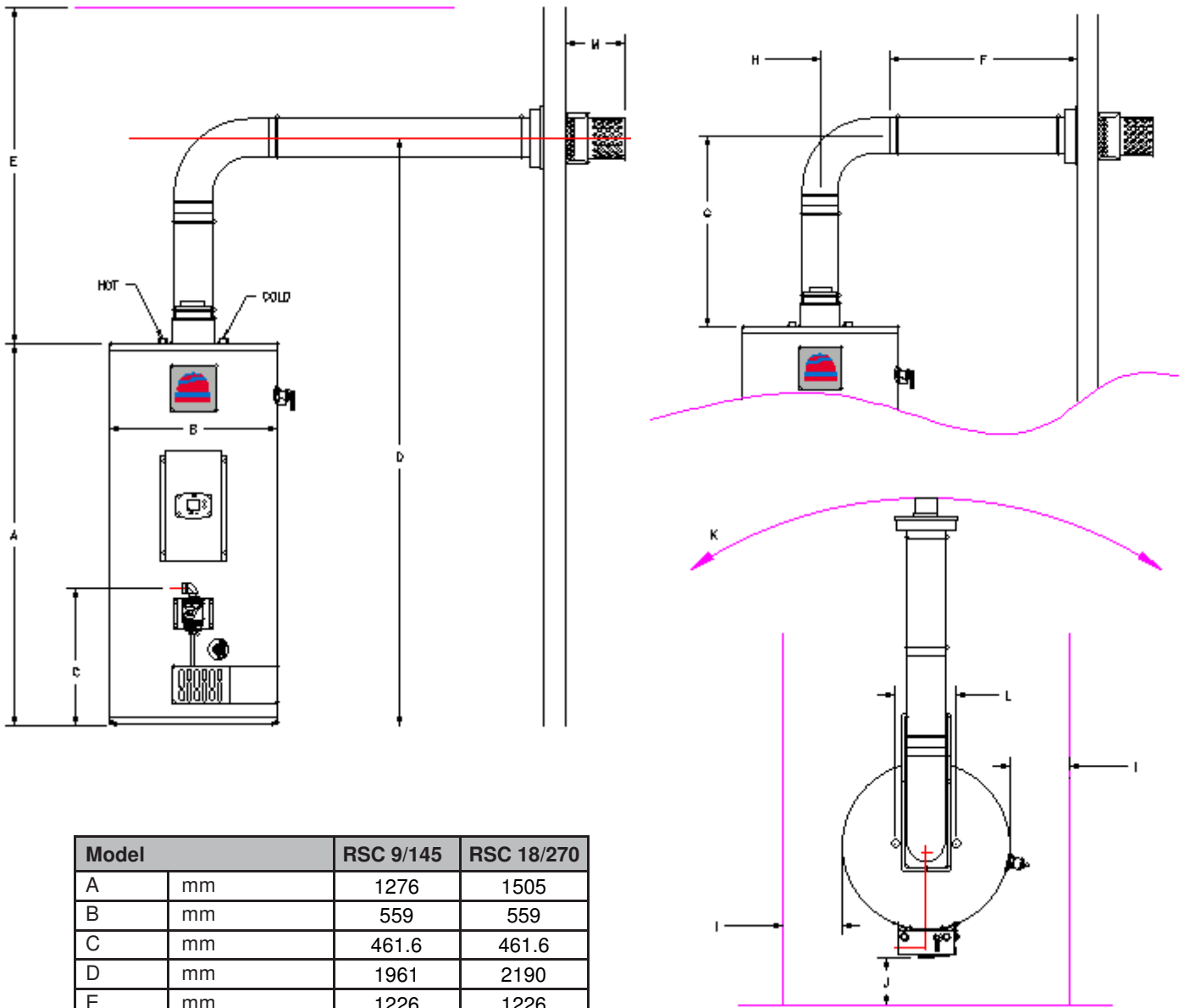

Model		RSC 9/145	RSC 18/270
A	mm	1276	1505
B	mm	559	559
C	mm	461.6	461.6
D	mm	1961	2190
E	mm	1226	1226
F	mm	750	750
G	mm	854	854
H	mm	194	194
I	mm	305	305
J	mm	610	610
K	mm	The flue outlet can be installed in any configuration through 180° as long as proper service clearances are observed.	
L	mm	203.2	203.2
M	mm	170	170

2.2 CLASSICflo Balanced Flue connections & technical data

Natural Gas			
BWC Models	Unit	URG2DV40S	URG2DV50S
Andrews Models		RSC 9/145	RSC 9/180
Input (gross)	kW	11.1	11.1
Input (net)	kW	10.0	10.0
Output (gross)	kW	8.88	8.88
Efficiency (Net CV)	%	88.80	88.80
Efficiency (Gross. thermal)	%	80	80
Gas Flow Rate	m ³ /hr	0.93	0.93
Nominal Gas Inlet Pressure	mbar	18 - 25	18 - 25
Main Burner Pressure	mbar	12.0	12.0
NOx	ppm	8	12
NOx	mg/kWh	15	21
CO2 Flue Gas	%	8.50 - 9.00	8.50 - 9.00
Noise Level	dBA	N/A	N/A
Recovery Rate (through 50°C rise)	l/h	152	152
Recovery Rate (through 56°C rise)	l/h	136	136
Minimum Flow Rate	l/s	N/A	N/A
Water Content	Litres	145	179
Weight Empty	kg	71	79
Weight Full	kg	216	258
Shipping Weight	kg	80	89
Storage Losses	kWh/l/day	N/A	N/A
Inlet/Outlet Connections	Inch BSP	3/4"	3/4"
Return Connection	Inch BSP	3/4"	3/4"
Gas Connection	Inch BSP	1/2"	1/2"
Condensate Connection	mm	N/A	N/A
Twin Pipe Conventional	mm	N/A	N/A
Flue Diameter (secondary)	mm	80 - 125	80 - 125
Flue Diameter (concentric)	mm	N/A	N/A
Ionisation Current (min)	µA	0.8	0.8
Ionisation Current (max)	µA	30	30
Electrical Requirements	V	230	230
Power Consumption	W	120	120
Fuse Rating	A	5	5
Maximum Flue Gas Temperature	°C	300	300
Flue Static Pressure	mbar	N/A	N/A
Waterside Pressure Loss	kPa	N/A	N/A
Maximum Outlet Temperature	°C	80	80
Maximum Working Pressure	Bar	10.3	10.3
Minimum Working Pressure	Bar	1.0	1.0
Diameter	mm	559	559
Water Heater Height	mm	1276	1505
Height to Vent Connection	mm	1613	1842

2.3 ErP data

CLASSICflo Balanced Flue		RSC 9/145	RSC 9/180
Declared load profile		XL	XL
Water heating energy efficiency class		B	B
Water heating energy efficiency	%	68	67
Annual energy consumption	kWh ⁽¹⁾	62	62
Annual energy consumption	GJ ⁽²⁾	22	22
Other load profiles for which the water heater is suitable to use and the corresponding water heating energy efficiency and annual electricity		-	-
Thermostat temperature setting	°C	60	60
Sound power level L _{WA} indoors	dB	40	40
Ability to off-peak hours functioning ⁽³⁾		-	-
Enables smart control settings ⁽⁴⁾		-	-
(1) Electricity (2) Fuel (3) If applicable. (4) If smart control settings value is "1", the water heating energy efficiency and annual electricity and fuel consumption only relate to enabled smart control settings.			

CLASSICflo Balanced Flue Natural Gas			RSC 9/145	RSC 9/180
Daily electricity consumption	Q _{elec}	kWh		
Declared load profile			XL	XL
Sound power level, indoors	L _{WA}	dB	40	40
Daily fuel consumption	Q _{fuel}	kWh	30	30
Emissions of nitrogen oxides	NO _x	mg/kWh	15	21
Weekly fuel consumption with smart controls	Q _{fuel, week, smart}	kWh	-	-
Weekly electricity consumption with smart controls	Q _{elec, week, smart}	kWh	-	-
Weekly fuel consumption without smart controls	Q _{fuel, week}	kWh	-	-
Weekly electricity consumption without smart controls	Q _{elec, week}	kWh	-	-
Storage volume	V	l	208	212
Mixed water at 40 °C	V ₄₀	l	165	193
Harmonised standards applied	EN: 13203-2			
Specific precautions that shall be taken when the water heater is assembled, installed or maintained:	Before any assembly, installation or maintenance the installation and operation manual has to be read attentively and be followed			

3 Installation

3.1 Introduction

The law requires that installation is carried out by a properly qualified person

Install in accordance with current British Standard Code of Practice 342 part 2 and British Standards 5440, 5546, 6644, 6700, 6798 and 6891.

3.2 Location

The location chosen for the heater must permit the provision of a satisfactory flue and an adequate air supply.

The heater must not be installed in a room which contains a bath or a shower and must not be installed in a bedroom or bedsitting room.

A clearance of 300mm should be left around the heater for fitting and servicing purposes and 762mm above the heater for removal of the flue baffle. The above clearances are recommended for ease of servicing. They can be reduced if necessary but a clearance of 300mm must be left in front of heater for access to the burner and controls. The flue baffle clearance should also be maintained if possible to avoid servicing problems.

The floor on which the heater is installed must be flat, level and of sufficient strength to withstand the weight of the heater when filled with water, and should satisfy the requirements of the Local Authority & Building Regulations.

Any combustible material adjacent to the heater must be so placed or shielded as to ensure that its temperature does not exceed 65°C.

3.3 Flue System



See

Detailed recommendations for flueing are given in British Gas booklet IM/11 and BS 5440 part 1. The following notes are intended to give general guidance:



Note

- **Route.** The route of the flue is not critical but, when planning horizontal runs, potential condensate traps must be avoided by maintaining a fall of 3° back to the appliance.
When calculating maximum flue runs, a reduction must be made of 2m per 90° bend and 1.5m per 45° bend.
- **Location.** The siting of the flue terminal is not critical with respect to the performance of the unit. However, areas where the discharge of combustion products would cause a nuisance should be avoided and it should be positioned in the wall or roof correctly using appropriate wall cover plates and flashing kits. In accessible positions a suitable guard should be provided.

Fig. 2

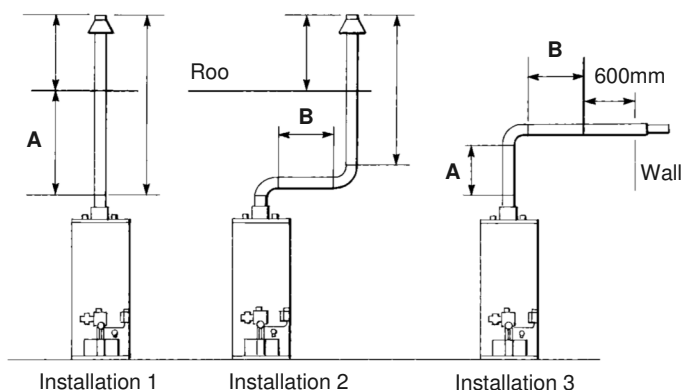

Detailed recommendations for flueing are given in British Gas booklet IM/11 and BS 5440 part 1. The following notes are intended to give general guidance:

Note

- A horizontal or vertical flue kit is supplied with each heater. Flue fitting instructions on page 12.
- Location. The siting of the flue terminal is not critical with respect to the performance of the unit. However, areas where the discharge of combustion products would cause a nuisance should be avoided. In accessible positions a suitable guard should be provided. (see page 12).
- Route. The route of the flue is not critical, with three installation options available. See below for permissible flue lengths. Where installation options 2 or 3 are used we recommend that the flue outlet can be installed in any configuration through 180° as long as proper service clearances are observed, see fig.2.

Model RSC 9/145			
Flueing Option	Installation 1	Installation 2	Installation 3
Type of Flueing	C31	C31	C11
Flue Restrictor	Ø 45mm	Ø 50mm	Ø 60mm
A	≤ 2.0	-	≥ 0.5m and ≤ 1.0m
B	-	≤ 1.0m	≤1.0m

Model RSC 9/180			
Flueing Option	Installation 1	Installation 2	Installation 3
Type of Flueing	C31	C31	C11
Flue Restrictor	Ø 48mm	Ø 55mm	No restrictor required
A	≤ 2.0	-	≥ 0.5m and ≤ 1.0m
B	-	≤ 1.0m	≤1.0m

3.4 Flue Fitting Instructions

Fig. 3

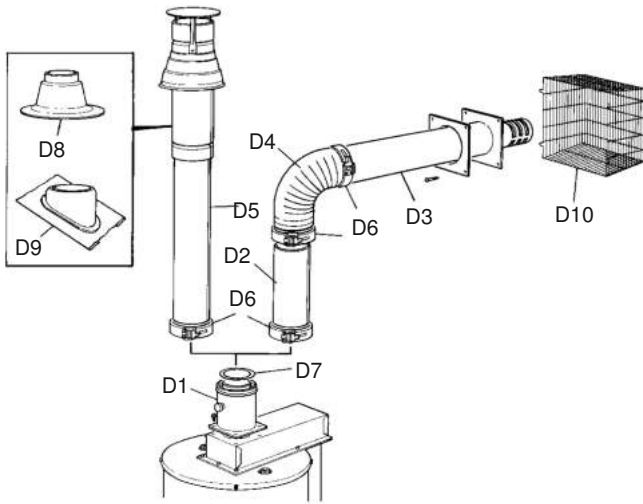

1. Fit heater adaptor D1 to heater ensuring correct location on primary flue spigot from heater. (Use 4 self tapping screws provided).
2. Fit flue restrictor ring D7 into heater adaptor D1. The correct size of restrictor for each heater model and installation is shown on page 11.
3. Fit flue section D2 into heater adaptor D1.
4. Fit elbow D4 into flue section D2 for horizontal flue runs.
5. Determine correct position of flue outlet and fit outer wall plate and inner wall plate. Fit flue outlet guard if required. (Fixings not supplied).
6. Fit horizontal terminal D3 or make up lengths of flue required (see page 11) into elbow D4. Each joint must be secured with a sealed clamp D6.
7. For vertical installations fit flue lengths required (see page 11) into heater adaptor D1.
8. Determine correct position of flue terminal and fit either D8 or D9 roof plates.
9. Fit D5 vertical terminal through roof plate into vertical flue pipe.
10. Fit D6 sealed clamps on all joints.
11. On all installations the lengths of flue pipes may be cut to obtain correct length of flue route required.

3.5 Air Supply



See

Detailed recommendations for air supply are given in BS 5440 part 2.

The following notes are intended to give general guidance:

Where the heater is to be installed in a room or internal space the heater requires the room or internal space containing it to have a permanent air vent. The vent must be either direct to outside air or to an adjacent room or internal space which must itself have a permanent vent of at least the same size direct to outside air. The minimum effective area of the permanent air vent(s) required is as follows:

5 cm² per kW in excess of 7 kW

Where the heater is to be installed in a compartment, permanent air vents are required in the compartment at high and low level. These air vents must either communicate with a room or internal space or be direct to outside air.

The minimum effective areas of the permanent air vents required in the compartment are as follows:-

Position of Air Vents	Air Vent Areas	
	Air from room or internal space	Air direct from outside
High Level	10cm ² per kW	5cm ² per kW
Low Level	20cm ² per kW	10cm ² per kW



Note

Both air vents must communicate with the same room or internal space or must both be on the same wall to outside air.

Where compartment air vents are open to a room or internal space, the room or internal space must itself have a permanent air vent(s) as previously specified.

For multiple installations where the total heat input exceeds 60 kW (204,720 BTU's/hr), reference must be made to BS 6644. The table on p7 should be used to calculate requirements. Detailed recommendations are given in BS 6644 Clause 19.

The following notes are intended to give general guidance. Ventilation shall prevent the heater environment from exceeding 32°C.

The purpose provided space housing the heater(s) must have permanent air vents communicating directly with the outside air, at high and low level. Where communication with the outside air is possible only by means of high level air vents, ducting down to floor level for the lower vents should be used.

For an exposed building, air vents should be fitted preferable on all four sides, but on at least two sides.

Air vents should have negligible resistance and must not be sited in any position where they are likely to be easily blocked or flooded or in any position adjacent to an extraction system which is carrying flammable vapour or other contaminated air.

3.6 Important

The supply of air to a space housing the heater(s) by mechanical means should be:-

- a) Mechanical inlet with natural extraction.
- b) Mechanical inlet with mechanical extraction.

NB - Natural inlet with mechanical extraction must not be used.

Where a mechanical inlet and mechanical extraction system is used, the design extraction rate must not exceed one third of the design inlet rate.

All mechanical ventilation systems must be fitted with automatic gas shut off safety systems which cut off the supply of gas to the heater(s) in the event of failure of either the inlet or extract fans.

NB - The vapours given off by halogen based compounds can, if drawn into the combustion air, cause corrosion of the Storage Vessel and premature failure of the thermocouple.

If water heaters are to be installed in locations where halogens are likely to be present they should be isolated from such compounds and ventilated from and to outside, uncontaminated, atmosphere.

Some of the vulnerable areas are listed below:-

- i) Hairdressing salons and adjoining rooms and basements.
- ii) Establishments where dry cleaning solutions are used or stored.
- iii) De-greasing plants using hydrocarbon solvents.
- iv) Premises where refrigerant gases are used or stored.
- v) Environments with dust laden atmosphere

3.7 Water Quality and Treatment

Where extreme conditions of water hardness exist, scale can form in any water heating equipment, especially when the heater is working under conditions of constant heavy demand and at high temperatures.

Each water heater is fitted with one or more magnesium anode(s) which protect the tank from corrosion caused by electrolytic action. Magnesium anodes are sacrificial in that they corrode as they protect. When the anode has eroded to less than 50% of its original diameter, it may not offer protection. The anodes should be inspected annually and replaced as necessary. Frequency of anode replacement will vary dependent on water quality.

Andrews Water Heaters offer Correx™ UP powered anodes as an alternative to the standard magnesium anodes. These anodes do not need maintenance or replacement. The potentiostat which regulates the current to the Correx™ anode, features an indicator light which shows green to indicate correct function and red to indicate malfunction. These anodes are available as an optional extra on all Andrews heaters.

In hard water areas, scale formation can occur in hot water systems and hot water heaters and the higher the temperature and volume of water used, the more problematic the scale build-up can be. Water treatment is normally recommended when the hardness reaches 100 - 150ppm (7 - 10 degrees Clark) and above. This problem can be minimised by reducing the water temperature in the heater and by fitting suitable water pre-treatment equipment.

**Note**

When installing Andrews Water Heaters in hard water areas we would recommend that a water treatment specialist is consulted.

3.8 Water Connections - General

Fig. 4

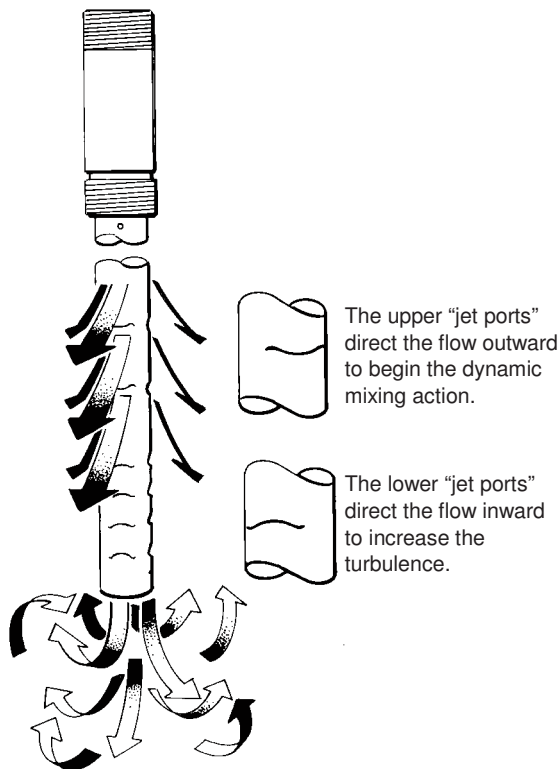
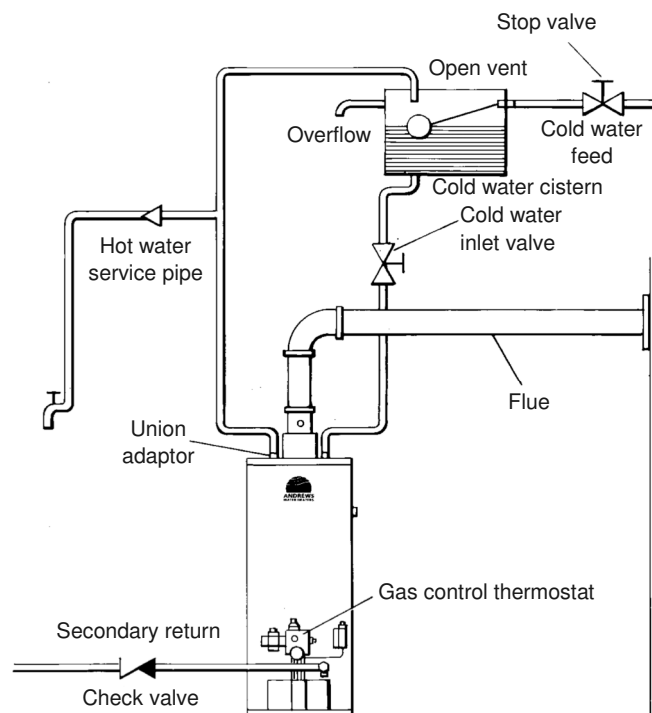

Fig. 5



3.8.1 Hydrojet® System

The heater is fitted with the Hydrojet® Total Performance System incorporated in the cold inlet dip tube. The tube is designed to increase turbulence and reduce sediment build up, reduce thermal stacking and increase delivery.

3.8.2 Water Connections - Vented Systems

The water heater must be supplied from a cold water feed cistern and the hot water supply pipe must be fitted with an open vent pipe in accordance with BS 5546. Local regulations and by-laws must be observed when installing the system but typical water service layouts are shown in Figs. 5.

The cold water feed cistern must have an actual capacity greater than the hourly recovery rate of the heater or heaters to which it is fitted, the minimum actual capacity allowed for a feed cistern is 227 litres.

The actual cistern capacity is the capacity to the normal water line of the cistern. All cisterns used should be to the relevant British Standard and the distance from the normal water line to the top of the cistern should be as laid down by the water authorities.

The cold water inlet and hot water outlet are identified on top of the heater. Connect the cold water feed and hot water outlet to these nipples with union adaptors for ease of servicing.



See

See Servicing Section 6.



Caution

Do not apply heat to these nipples if making capillary soldered joints as they are fitted with plastic inserts. Make the capillary joints to the pipes before connecting to the heater. A drain cock is supplied with the heater and this should be fitted to the appropriate boss as shown on the drawing.

After installation of the water system open the main water supply valve, flush the system and fill the heater. Open the hot taps to allow air to escape from the system. When the system is free of air, close the taps and check for leaks at the gas control thermostat, drain cock and pipe connections at the top of the heater.

3.8.3 Water Connections - Unvented Systems

Unvented Systems should be fitted by an Approved Installer.

When used in an unvented system, the Andrews Water Heater will supply hot water at a pressure of 3.5bar (50.8lbf/in²) provided that this pressure is available at the mains feed. During conditions of no-flow, system pressure may rise to a maximum of 6bar (87lbf/in²) whilst the burner is operating. When testing the system, it is recommended that a maximum test pressure of 8.62bar (125lbf/in²) is employed.

The heater can be used on unvented hot water storage systems, with the addition of an Unvented Systems Kit, part number B171 available from Andrews Water Heaters.

All fittings and materials must be suitable for use with drinking water and listed in the current Water Research Centre "Materials and Fittings Directory".

Installation of unvented hot storage water systems must comply with part G of Schedule 1 of the Current Building Regulations.

See Fig.8 lists and illustrates the component parts of the Unvented Systems Kit.

Fig.6 illustrates the general arrangement of the components.

The Wall Mounting Kit is available as an optional extra.

Items D4/D6 must be fitted into the Temperature Relief port (see Fig.6).

When assembling items D1 and D2 care must be taken to ensure that the flow arrows marked on the components are pointing in the direction of flow i.e. towards the water heater.

The cold water for services may be drawn from the 22mm compression port on item D1(a). The water pressure at this point will be similar to that available at the hot water outlet of the water heater. If port (a) is not used it should be sealed with the blanking plug supplied.

If higher flow rates are required for the cold water services a suitable "tee" fitting should be included in the pipework upstream of item D1.

The pipework fitted to both tundish outlets should be at least 28mm diameter and should be terminated at a suitable drain (see Current Building Regulations Approved Document G3).

Fig. 6

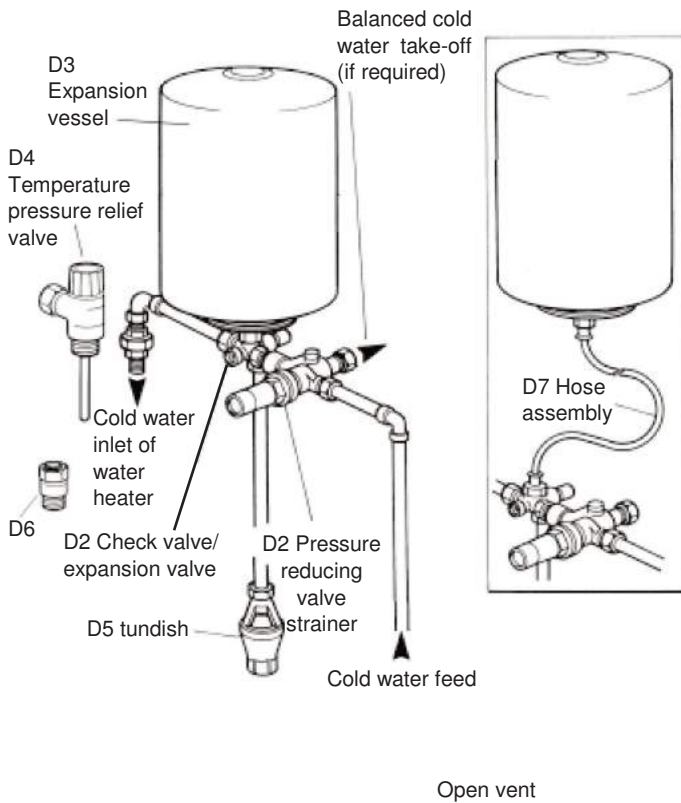
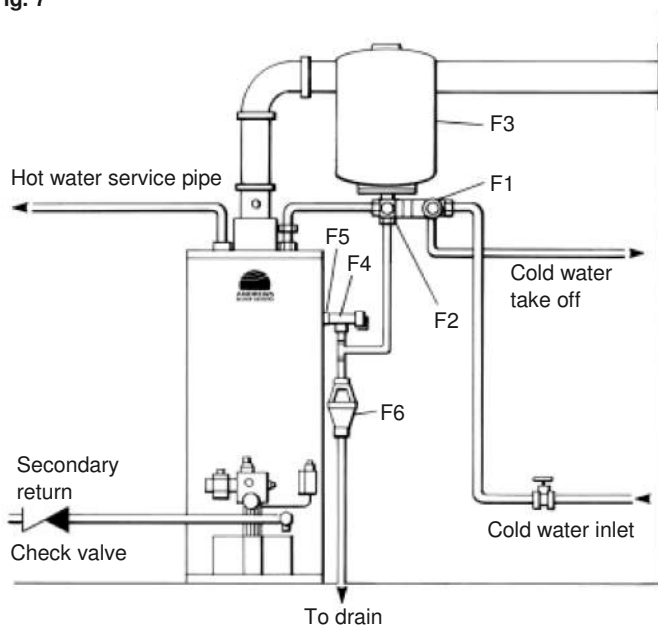
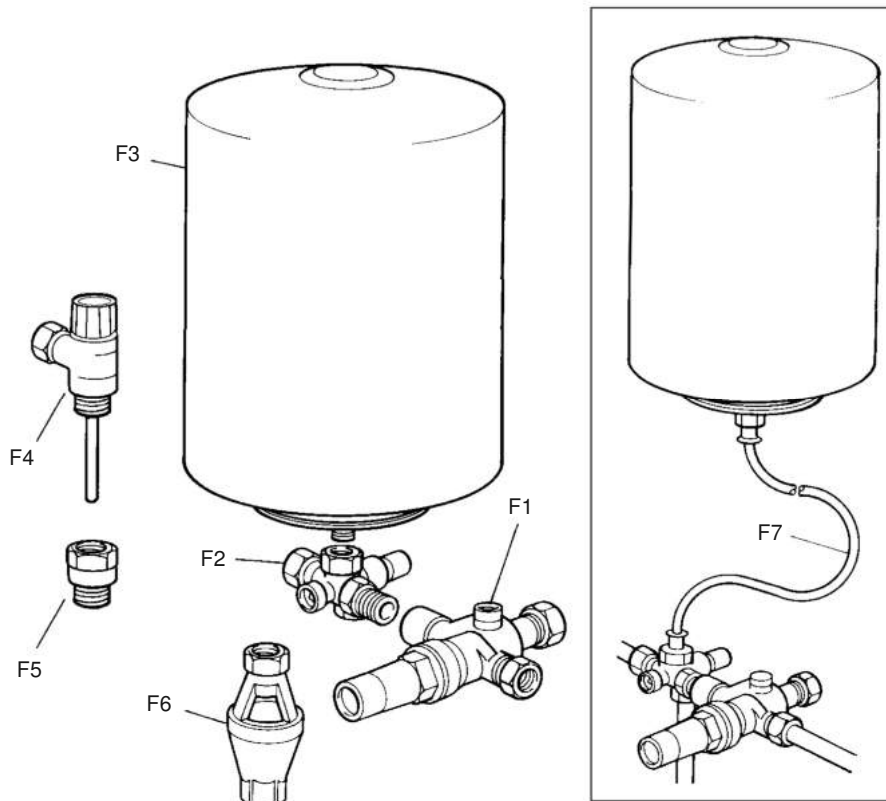

Fig. 7



3.8.4 Unvented Systems Kit

Fig. 8



3.8.5 Unvented Systems Kit - Parts List

Ref.	Part No.	Description	Qty
	7703928	Unvented Systems Kit Complete	1
Comprises			
F1&2	7705036	Pressure Reducing /Check/Expanson Valve	1
F3	7705037	Expansion Vessel 24L	1
F4	7705038	T/P Relief Valve 7 bar/95°C x 3/4"	1
F6	7705039	Tundish	1
F5	7705040	Adaptor 3/4"	1
F7	7705041	Hose Assy	1

3.9 Gas Connections

THE APPLIANCE MUST ONLY BE USED WITH NATURAL GAS.

The installation of the gas supply should conform to the requirements of IM/16 published by British Gas p.l.c. or BS 6891. Jointing compound used must conform to BS 5292 pt 5.



Caution

Do not apply heat in close proximity to the gas control as this will result in damage occurring to the control.

Fit the 1/2 m/f elbow into the gas control valve. Fit the 1/2 gas supply cock immediately upstream of the gas control and elbow and connect to the gas supply. Pressure test the gas installation for soundness. If any doubt exists as to size of gas supply pipe, consult your local Gas Region.

It is recommended that a pressure test point is fitted on the input next to the gas supply valve.

3.10 Electrical Supply

The method of connection to the mains electricity supply should facilitate complete electrical isolation of the appliance preferably by use of an unswitched fused spur.

Alternatively, a fused double pole switch or fused spur box, serving only the heater, may be used. A 3mm separation is required between each pole.

The point of connection to the mains should be readily accessible and adjacent to the appliance.

Wiring external to the water heater must be installed in accordance with the I.E.E. Regulations for the wiring of buildings and to any local regulations that may apply.

The Heater is designed to run off a permanent 220/240V 1 Ph 50 Hz supply and the fuse rating is 3 Amp.

3.11 Wiring Diagram

Fig. 9

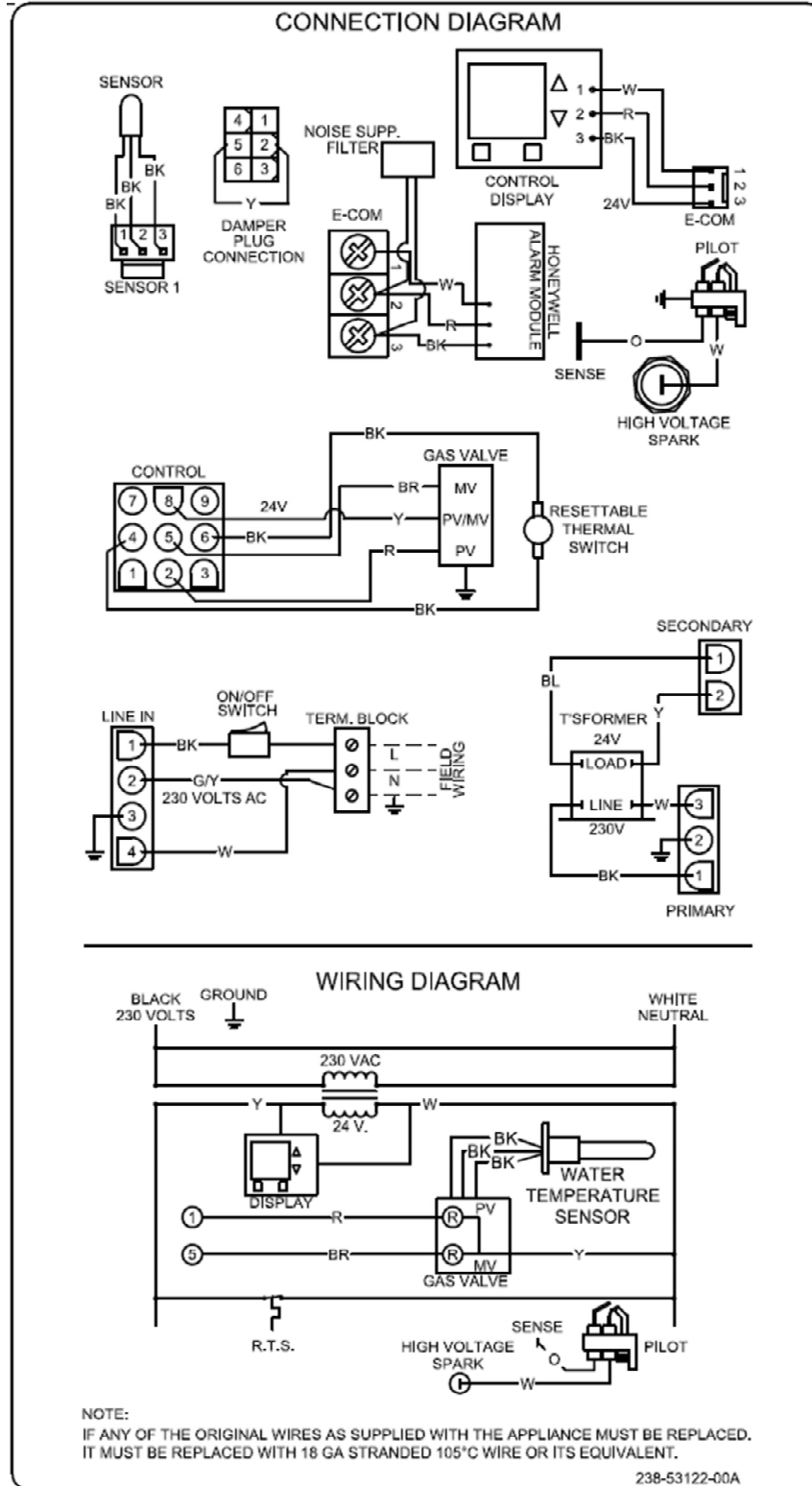

4 Commissioning

4.1 20/190

4.1.1 To Light the Burner

**Caution**

Do not operate the water heater until the storage vessel is completely filled with water, with water running from all hot taps.

Open the main gas supply valve after all connections to the gas control valve are complete, and test all connections with leak spray.

1. Ensure electrical supply is on.
2. Ensure gas supply is on.
3. Change temperature format from °F to °C by following the steps in Fig. 20 on page 28.
4. Set the desired temperature by following Fig. 12 to 18 on pages 26 & 27.
5. Ensure time switch, if fitted is in the on position.
6. If the burner does not light, an error code will be displayed on control display.

4.1.2 To Shut off the Burner

To shut off the burner isolate the electrical supply, then shut off the gas service cock.

The water heater should only be turned OFF for long periods, eg holidays, or in an emergency. Otherwise the heater should be left to operate under normal thermostat control.

**Note**

When using a time control ensure the heater is not turned OFF before the final water draw off occurs. This will ensure the water in the tank is left in a hot condition.

4.2 Users Safety Guide



Note

For your safety read before lighting the appliance



Warning

1. Always follow manufacturers instructions when lighting the appliance. Failure to do so may result in damage to property, personal injury or loss of life.
2. Before lighting check all round the appliance area for gas.
3. Do not make any attempt to re-light the appliance if the main burner has extinguished. Wait at least 5 minutes to allow for any unburnt gas to disperse. Ventilate the area if possible.



Danger

FOR YOUR SAFETY IF YOU SMELL GAS

1. Turn off gas supply and open windows.
2. Do not operate electrical switches.
3. Extinguish any naked flames.
4. Contact gas supplier if the smell of gas persists.

FOR YOUR SAFETY

Do not store or use petrol, aerosol or other flammable vapours or liquids in the vicinity of this or any other atmospheric gas appliance.



Warning

Hotter water increases the risk of scalding. Before changing the temperature refer to instruction manual or data label. Hot water can produce third-degree burns in:

6 seconds at 60°C

30 seconds at 54°C

5 Operation

5.1 Burner Assembly

Fig. 10

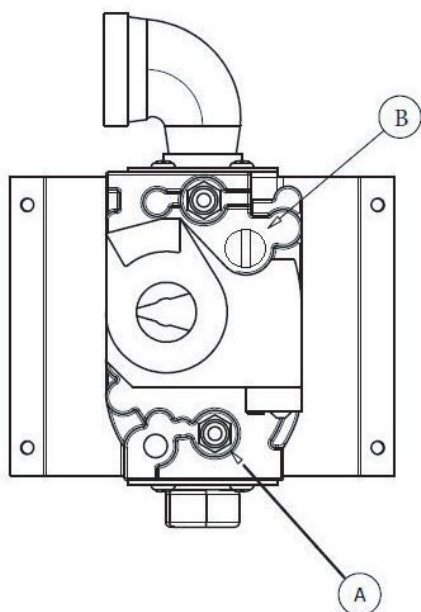

5.1.1 Checking Main Burner Pressure

1. Turn gas supply OFF.
2. Release bleed screw A and connect pressure gauge tube (See Fig. 10)
3. Light burner as described previously.
4. Remove cap from port B and adjust pressure using exposed screw using a 5mm allen key in accordance with data plate (See Fig. 10).
5. Shut OFF burner as described previously. Remove pressure gauge tube and tighten bleed screw A.
6. Re-light burner as described previously.

When properly installed and adjusted the Heater will require the minimum of attention. Should it become necessary to completely drain the heater, close the cold water inlet valve, open a hot water tap to allow air to enter the system. Fit a suitable hose to the drain cock and open.

Whenever the Heater is filled with cold water condensation will form on the cold storage vessel surfaces when the burner is lit. Condensation is normal and does not indicate a leak. It will disappear when the storage vessel becomes heated.

The control thermostat fitted to this heater has a built in limit thermostat (ECO). In the event of high water temperature the gas supply will be shut off automatically. The high temperature condition must be identified and rectified before the heater is relit. See Section 7 (fault finding).

i **Note**
If in doubt contact Andrews Water Heaters

5.2 Burner flame check

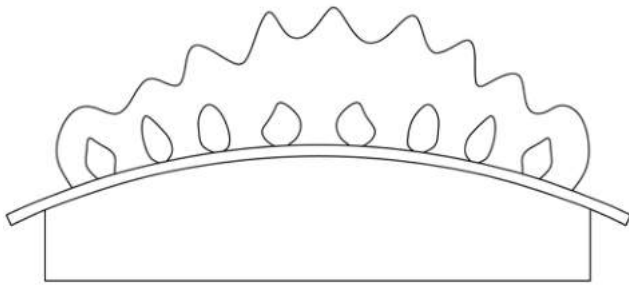

NATURAL GAS BURNER

Fig. 11

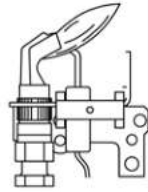

PILOT IN OPERATION

Steel Burner: These models are equipped with self-adjusting air mixture and do not have an adjustable air shutter. At the time of installation and during annual maintenance, a visual check of the pilot and burner flames should be made to determine if they are burning properly. The burner flames should be blue with yellow tips. A blue-orange flame is characteristic of operation on liquefied petroleum (LPG) gas.



Note

IMPORTANT- In the event of an emergency, turn off the gas and electric (if applicable) to the appliance.

IMPORTANT- The water heater should be inspected at a minimum annually by a qualified service technician for damaged components and/or joints not sealed. **DO NOT** operate this water heater if any part is found damaged or if any joint is found not sealed.



Warning

Water heaters are heat producing appliances. To avoid damage or injury there shall be no materials stored against the water heater or flue system, and proper care shall be taken to avoid unnecessary contact (especially by children) with the water heater and flue system.

UNDER NO CIRCUMSTANCES SHALL FLAMMABLE MATERIALS, SUCH AS PETROL OR PAINT THINNER BE USED OR STORED IN THE VICINITY OF THIS WATER HEATER, VENT SYSTEM OR IN ANY LOCATION FROM WHICH FUMES COULD REACH THE WATER HEATER OR FLUE SYSTEM.

5.3 Control sequence of operation

5.3.1 Start-up sequence

Upon powering up, the control checks for the presence of the resistive plug. If the resistance is in the expected range, the control will begin normal operation after 5 to 8 seconds.

5.3.2 Sequence of operation

1. A call for heat from thermostat
2. Igniter warm-up
3. Main burner ON
4. Flame signal confirmed
5. Thermostat satisfied
6. Main burner OFF

5.4 Temperature selection procedure

For energy efficient operation of your water heater, the suggested initial temperature setting is 60°C.



Warning

If the water heater display does not show 'Operational' in the 'Status' indicator, there may be an operating malfunction with the water heater. If this is the case, a numeric code will be displayed. Refer to the label next to the display for the definition of the error code and call your plumbing professional or service agent to service the water heater. Do not try to reset the water heater without having a qualified service person to diagnose and correct the problem. If the display is blank or does not show an error code, make sure there is power to the water heater.

Setting the water temperature to the maximum setpoint can result in scalding hot water delivered to the taps. It is highly recommended that the maximum setpoint be adjusted to the lowest possible for the needs of the installation. See following section to change the maximum setpoint limit (max setpoint). Make sure the water heater control display is not in a public area that can result in the temperature settings being improperly adjusted.



Note

When the maximum setpoint is reached, the display will show 'Max Setpoint' without the setpoint value. The maximum setting is equal to approximately 82°C. The default temperature setpoint from the factory is 60°C.

5.4.1 Water heater display and control buttons

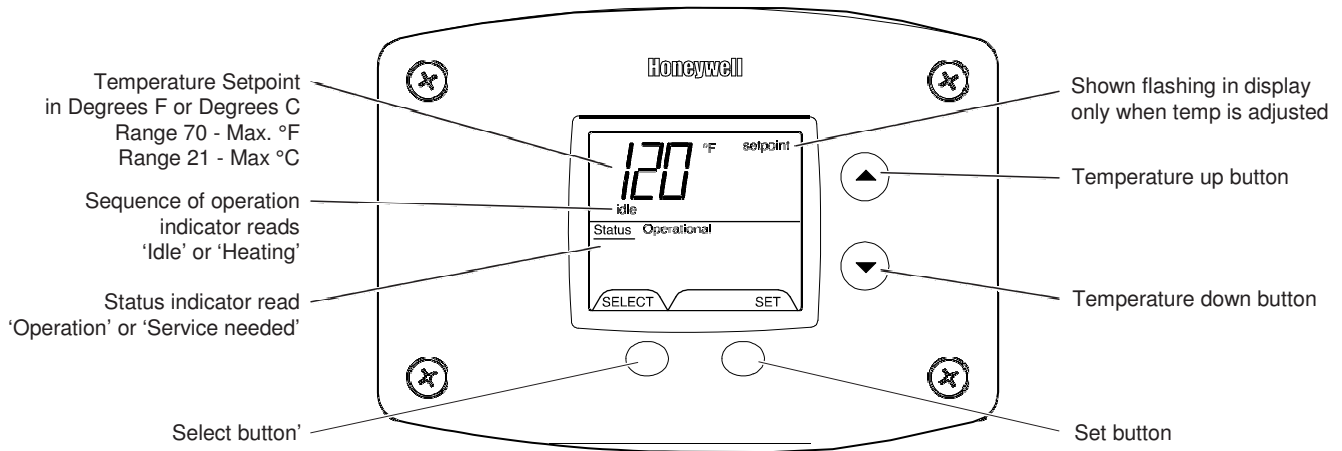

Fig. 12

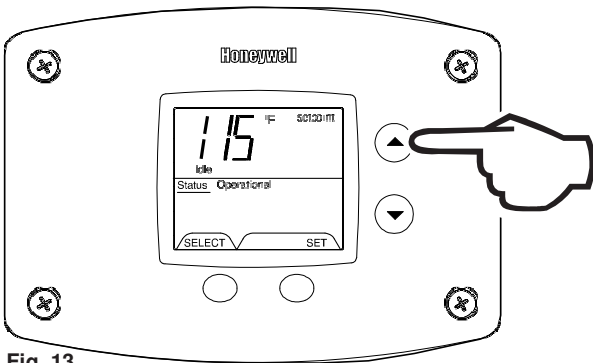

Fig. 13

5.4.2 To increase Setpoint temperature

1. Depress and hold 'Temperature Up' button until desired setpoint temperature appears in the display (Fig. 13).

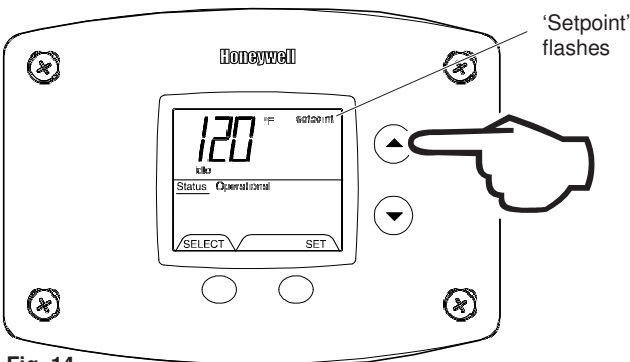

Fig. 14

2. 'Setpoint' indicator begins flashing in the display after pressing 'Temperature Up' button (Fig. 14).

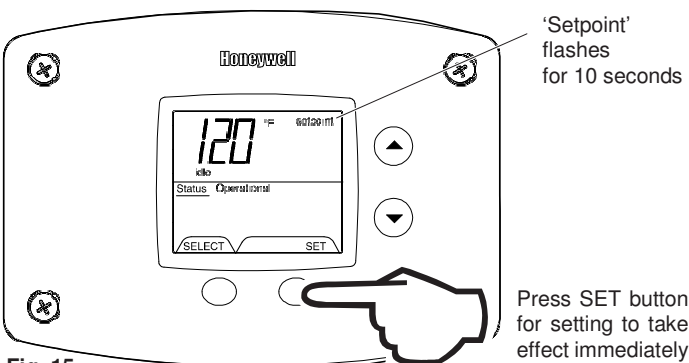

Fig. 15

3. Press 'SET' button for new setting to take effect immediately. 'Setpoint' will stop flashing. If the "SET" button is not pressed, the new temperature setting will take effect in approximately 10 seconds (Fig. 15).

5.4.3 To decrease Setpoint temperature

1. Depress and hold 'Temperature Down' button until desired setpoint temperature appears in the display (Fig. 16).

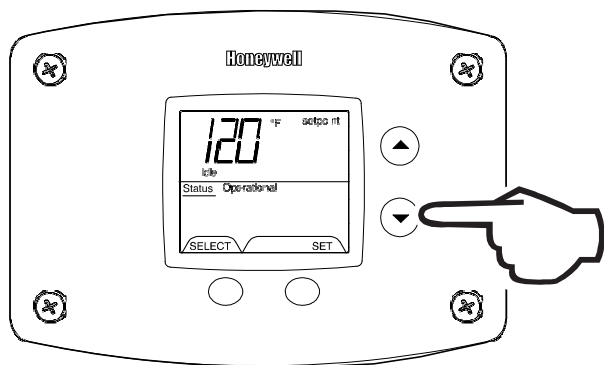

Fig. 16

2. 'Setpoint' indicator begins flashing in the display after pressing 'Temperature Down' button (Fig. 17).

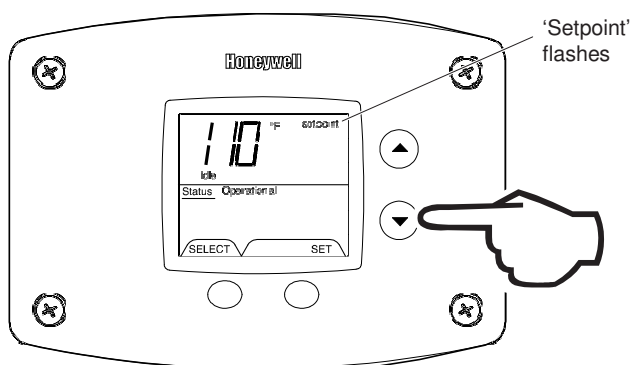

Fig. 17

3. Press 'SET' button for new setting to take effect immediately. 'Setpoint' will stop flashing. If the 'SET' button is not pressed, the new temperature setting will take effect in approximately 10 seconds (Fig. 18).

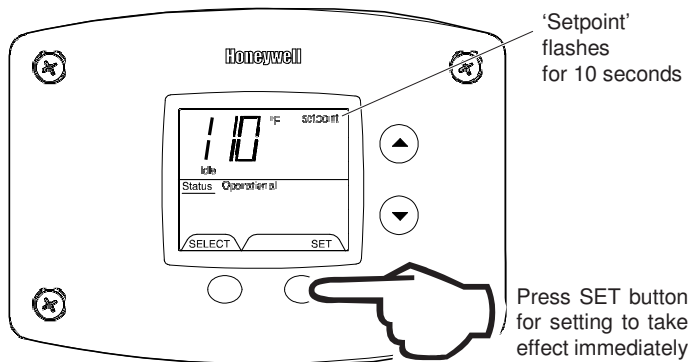

Fig. 18

5.4.4 To change temperature format in display from °F to °C or °C to °F

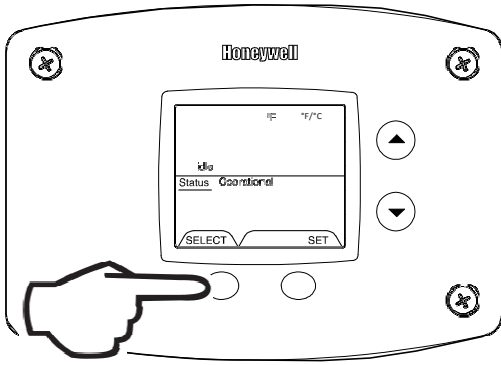

Fig. 19

1. Press 'SELECT' button until °F/ °C is displayed (Fig. 19).

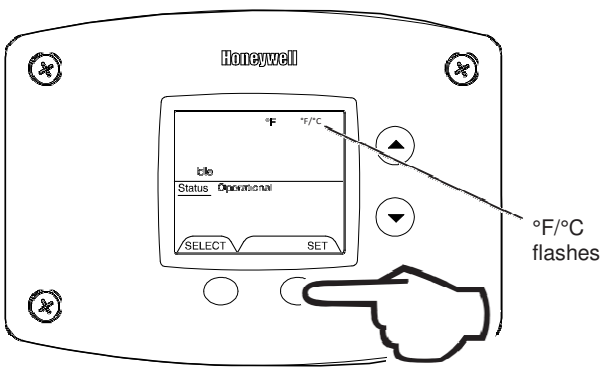

Fig. 20

2. Press 'SET' button to change temperature format. Symbol °F/ °C will flash (Fig. 20).

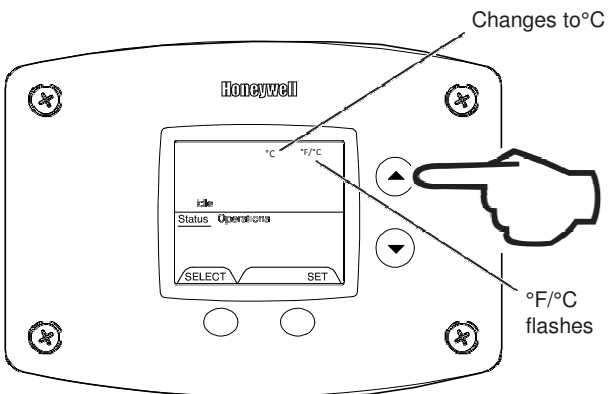

Fig. 21

3a. Press 'Temperature Up' button to change temperature format to °C (Fig. 21).

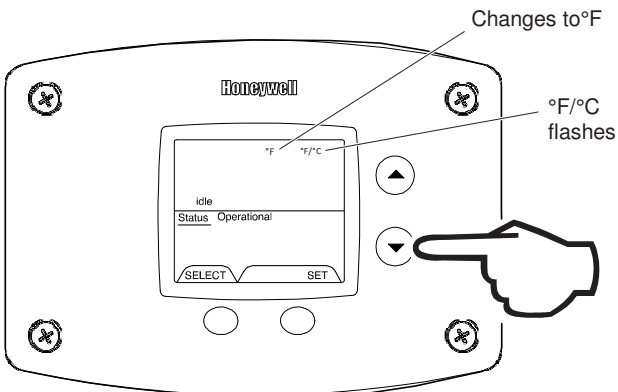

Fig. 22

3b. Press 'Temperature Down' button to change temperature format to °F (Fig. 22).

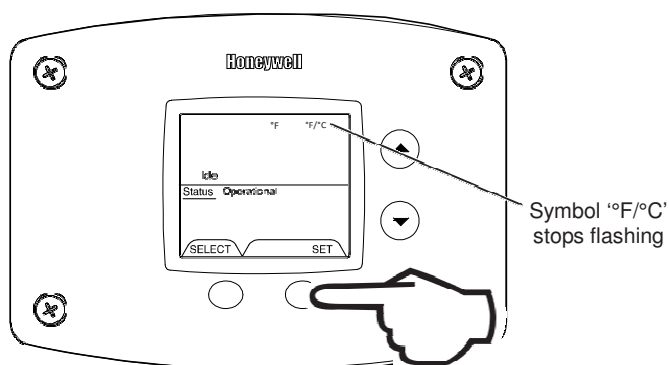

Fig. 23

- Press 'SET' button to confirm °F or °C format. F°/ °C will stop flashing. Setpoint display will appear in the format selected (°F or °C) in 10 seconds (Fig. 23).

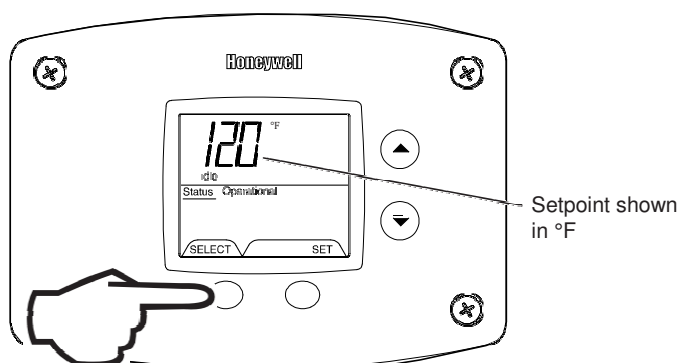

Fig. 24

- Pressing 'SELECT' button will return display to setpoint in format selected (°F or °C) immediately (Fig. 24).

An automatic gas shut-off device (ECO) is incorporated in the sensor and control board which will shut off all gas supply to the burner and pilot if the water heater temperature exceeds 93°C. Should the ECO function (open), the water temperature should be reduced to approximately 49°C and follow applicable Lighting Instructions to place the water heater in operation. The water heater must have the problem corrected by a qualified service person before putting the water heater back in operation. It is recommended that all service work be performed by Andrews Water Heaters Service Team.

If the water heater is to remain idle for 30 days or more or is subjected to freezing temperatures while shut off, the water heater and piping should be fully drained (See "To Drain the Water Heater") and the drain valve should be left fully open.



Warning

Hydrogen gas can be produced in an operating water heater that has not had water drawn from the tank for a long period of time (generally two weeks or more). Hydrogen gas is extremely flammable. To prevent the possibility of injury under these conditions, we recommend the hot water tap or outlets to be open for several minutes at the kitchen sink before you use any electrical appliance which is connected to the hot water system. If hydrogen is present, there will be an unusual sound such as air escaping through the pipes as hot water begins to flow. Do not smoke or have open flame near the hot water tap or outlets at the time it is open.

6 Servicing

6.1 Introduction

6.1.1 Servicing must be carried out by a properly qualified person.

Whilst giving the following instructions for the care of the Andrews Water Heater, the water heater is a gas appliance and as such should be serviced annually by either Andrews Water Heaters service team or a competent trained service engineer.

Water heaters are heat producing appliances. To avoid damage or injury there must be no materials stored against the water heater or vent-air intake system, and proper care must be taken to avoid unnecessary contact (especially by children) with the water heater and vent-air intake system. UNDER NO CIRCUMSTANCES MUST FLAMMABLE MATERIALS, SUCH AS GASOLINE OR PAINT THINNER BE USED OR STORED IN THE VICINITY OF THIS WATER HEATER, VENT-AIR INTAKE SYSTEM OR IN ANY LOCATION FROM WHICH FUMES COULD REACH THE WATER HEATER OR VENT-AIR INTAKE SYSTEM.



Important

The water heater should be inspected at a minimum annually by a qualified service technician for damaged components and/or joints not sealed. DO NOT operate this water heater if any part is found damaged or if any joint is found not sealed.

The following maintenance should be performed by a qualified service technician at the minimum periodic intervals suggested below. In some installations, the maintenance interval may be more frequent depending on the amount of use and the operating conditions of the water heater. Regular inspection and maintenance of the water heater and vent-air intake system will help to insure safe and reliable operation.

1. Annually check the operation of the thermostat.
2. The flow of combustion and ventilation air MUST NOT be restricted. Clear the combustion air openings of any dirt, dust, or other restrictions.



Warning

The ventilation air system may be HOT.

3. At all times keep the water heater area clear and free from combustible materials, gasoline and other flammable vapors and liquids.
4. Annually conduct a visual check of the main and pilot burner flames to determine that they are burning properly. See the Burner Flame Check section for illustration. If sooting or other burner anomalies are evident, shut down the water heater by turning off the gas per the instructions listed in this manual or as listed on the water heater.

5. Annually remove the inner door and main burner assembly to clean orifices and related parts of any dirt or other foreign material. Inspect the burner ports for obstructions or debris and clean with a wire brush as needed. Wire brush and/or vacuum clean the combustion chamber as needed to remove scale deposits and debris. NOTE: It is imperative for proper operation of the water heater that the inner door be replaced in the original location.



Warning

When lifting lever of the combination temperature and pressure relief valve, hot water will be released under pressure. Be careful that any released water does not result in bodily injury or property damage.

6. At least once a year, check the combination temperature and pressure relief valve to insure that the valve has not become encrusted with lime. Lift the lever at the top of the valve several times until the valve seats properly without leaking and operates freely.



Warning

Do not allow the water heater to run out of propane.

7. Monthly drain off a gallon of water to remove silt and sediment.



Warning

This water may be hot.

8. If the combination temperature and pressure relief valve on the appliance discharges periodically, this may be due to thermal expansion in a closed water supply system. Contact the water supplier or local plumbing inspector on how to correct this situation. Do not plug the combination temperature and pressure relief valve outlet.

9. Combination sacrificial anode rods have been installed to extend tank life. These anode rods should be inspected periodically (every 2 years) and replaced when necessary to prolong tank life. Water conditions in your area will influence the time interval for inspection and replacement of an anode rod. Contact the plumbing professional who installed the water heater or the manufacturer listed on the rating plate for anode replacement information. The use of a water softener may increase the speed of anode consumption. More frequent inspection of the anodes are needed when using softened (or phosphate treated) water.

10. The blower has sealed motor bearings and does not require adding oil.

FOR YOUR SAFETY, DO NOT ATTEMPT REPAIR OF GAS CONTROL, BURNERS OR GAS PIPING. REFER REPAIRS TO A QUALIFIED SERVICE TECHNICIAN.

Contact your supplier or plumbing professional for replacement parts or contact the company at the address given on the rating plate of the water heater.

Provide the part name, model and serial numbers of the water heater when ordering parts.

6 Servicing

6.2 Burner Assembly

6.2.1 The burner assembly should be cleaned and checked annually

1. Move the gas service cock to "OFF". Isolate from the electrical supply. Unhook and remove the outer door.
2. Disconnect from the bottom of the gas control valve, the pilot tube, gas control wiring loom.
3. Remove the 6 retaining screws from the burner plate and withdraw the burner assembly from the heater complete with blue ignition lead.
4. Remove the screw securing the pilot assembly to the main burner supply tube.
5. Remove the gland nut connecting the pilot tube to the pilot assembly. Withdraw the pilot tube and remove the pilot restrictor from the end. Clean the pilot restrictor and blow through the pilot burner with compressed air.

DO NOT ATTEMPT TO CLEAN ORIFICES OR MAIN BURNER SURFACE WITH SHARP METALLIC OBJECTS.

6. Re-assemble in the reverse order of steps 2 to 5 but note:
 - i) Be sure to engage the flattened flange of the main burner into the proper location in the bracket on the base pan of the heater.
7. Re-light and carry out commissioning check.



See

See section 4 commissioning.

6.3 Gas Control Valve

Fig. 25

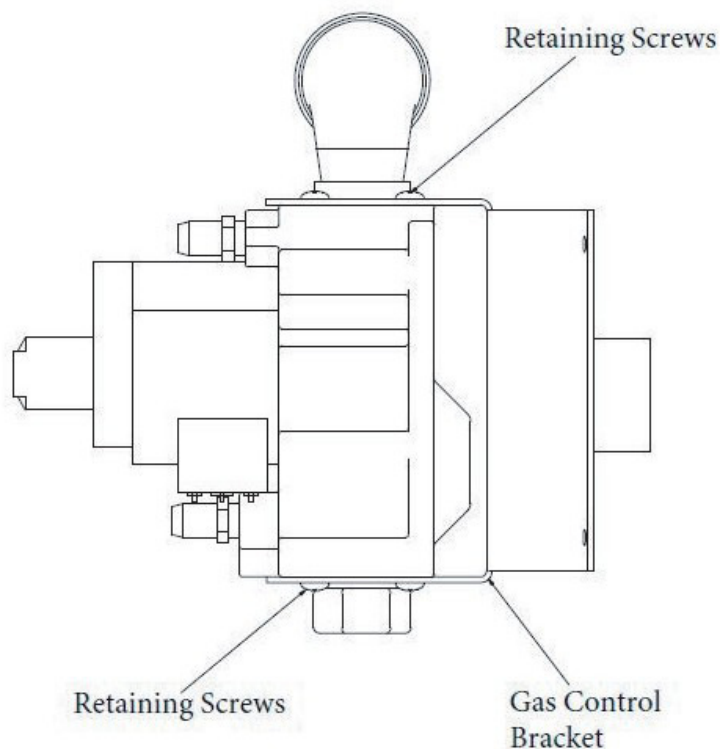

To remove gas control, unscrew four retaining screws at top and bottom of gas control bracket. Also it will be necessary to remove gas fittings at the top of the gas valve and the bottom of the gas valve. It is now possible to slide the gas control valve away from the gas valve retaining bracket.

This should be checked and serviced by an engineer fully conversant with every aspect of this piece of equipment.

To change the gas valve it is not necessary to drain down the water heater.

1. Isolate from the electrical supply. Unhook and remove the outer door and remove the inner door by sliding to the side on the 20/190 model, or by removing two screws on the 20/190 model.
2. Disconnect burner gas tube, pilot tube and blue ignition lead at gas control.
3. Remove burner assembly complete with pipes and blue ignition lead.
4. Disconnect electrical connection from the top of the heater. Remove the screws that hold the flue-fan in place and remove the flue fan.
5. Withdraw the flue baffle.
6. Clean the flueway with a brush and clean any deposit from the underside of the storage vessel bottom and from the flue baffle.
7. Re-assemble in the reverse order.



Note

It is important that the burner is correctly located in the burner support bracket on base of combustion chamber.

8. Re-light and carry out commissioning check.



See

See section 4 commissioning.

6.4 Magnesium Anode

A magnesium sacrificial anode is fitted in the water storage vessel. The function of the anode is to provide additional protection, against corrosion, for the inside of the vessel. The condition of the anode should be checked regularly and replaced. In order to remove the anode close the cold water feed stop valve, open a hot water tap and, by opening the water heater drain valve, drain off sufficient water to clear the top of the vessel. The anode/outlet nipple can then be unscrewed from the top of the heater.

The original diameter of the anode is 22mm. If, at any point along its length, the anode is eroded to half, or less, of the original diameter it should be replaced with new. Particular attention should be paid to the extreme ends.

If the anode is encrusted with limescale it should be either cleaned or replaced.

Where Correx Anodes are fitted no Anode maintenance is required.

6.5 Descaling Information

When descaling the storage water heater your attention is drawn to the following guidelines.



Caution

Due to the corrosive nature of descaling fluid, it is essential that suitable protective clothing is used and adequate ventilation available when descaling. It is important to follow descaling manufactures instructions before and during use.

1. Turn gas control on water heater to 'OFF' position and isolate the gas supply.
2. Close water inlet valve and drain heater tank.
3. Remove magnesium sacrificial anode if fitted.



Note

It is recommended that a new anode is fitted.

4. Add suitable hydrochloric based descale acid, the requirement is normally 5 litres for dependent on the amount of limescale present.
5. After a minimum of one hour restore gas supply and turn on main gas burner for 2 minutes.
6. Isolate gas supply and drain off descale fluid through drain port.
7. Open cold water feed valve and fill heater tank.
8. Drain and flush out heater for minimum of 30 minutes.
9. Replace anode.
10. Restore gas supply and re-light heater.

6.6 Accessing service mode on the water heater display (Service personnel only)

The display has a 'service mode' for changing the maximum setpoint and accessing information in aiding servicing of the water heater. This procedure is for service and installation personnel only. To enter the Service Mode, follow the steps illustrated below:

Warning  The following procedure is for service and installation personnel only. Resetting lockout conditions without correcting the malfunction can result in a hazardous condition.

1. Press 'Select' and 'Temperature Up' buttons together and hold for 3 seconds until 'Max Setpoint' is shown in the display (Fig. 26).

Note  30 Seconds after the last button press, the display will automatically return to the 'User Mode'. Simultaneously pressing the 'Select' and 'Temperature Up' buttons will switch the display immediately to the 'User Mode'.

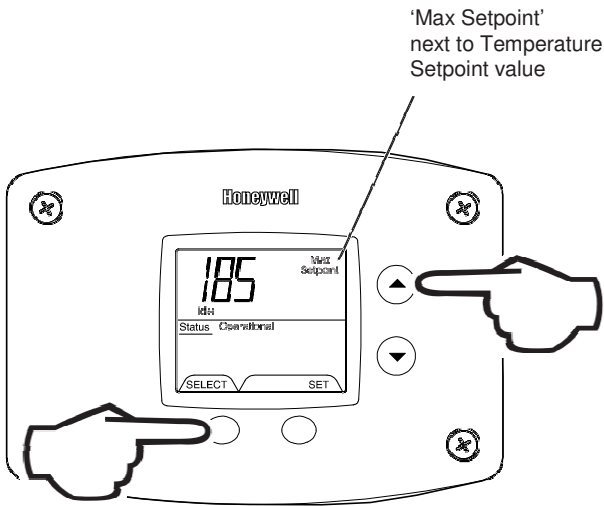

Fig. 26

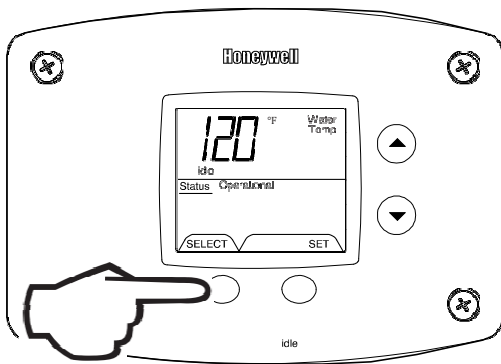

Fig. 27

2. Pressing 'Select' button will change display to next mode (Fig. 27).

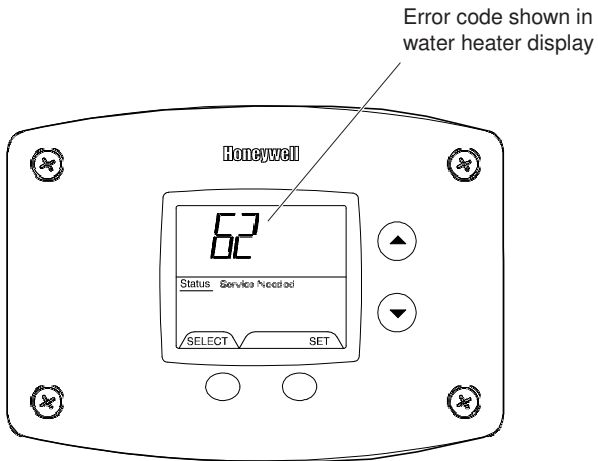

Fig. 28

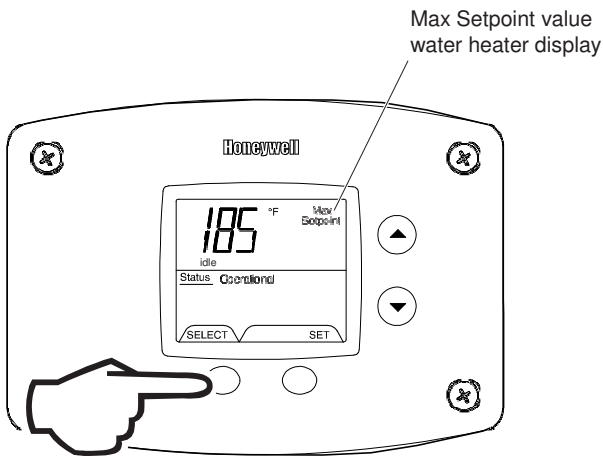

Fig. 29

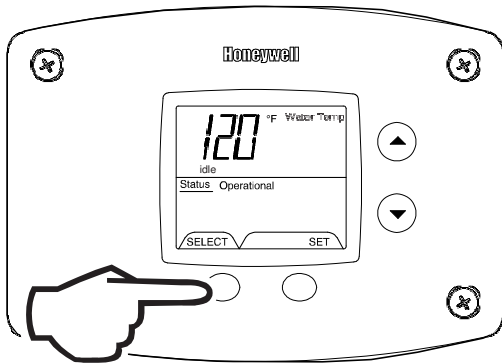

Fig. 30

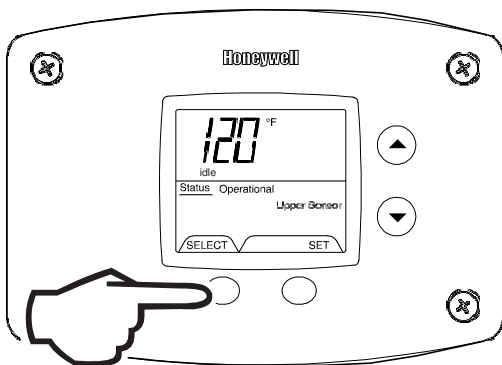

Fig. 31

6.6.1 Sequence of modes available in 'Service Mode' by pressing the 'Select' button

Error Code Number (Display/Reset). This is only shown if there is an operating error in the 'User Mode' (Fig. 28).

1. Max Setpoint (Display/Change) (Fig. 29).

2. Water Temperature Average (Displays average if there are two sensors – sensor temperature displayed if single sensor is used) (Fig. 30).

- 2b. Water Temperature - Upper Sensor (Displays if there is an upper sensor – some models) (Fig. 31).

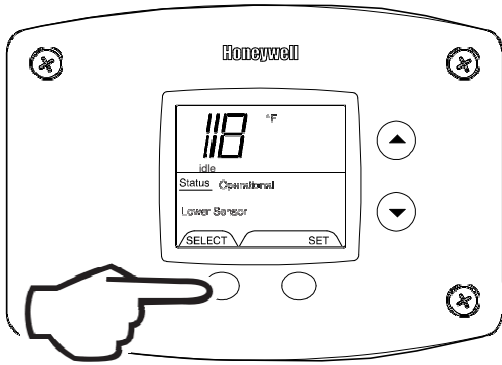

Fig. 32

2c. Water Temperature - Lower Sensor (Displays if there are two sensors) (Fig. 32).

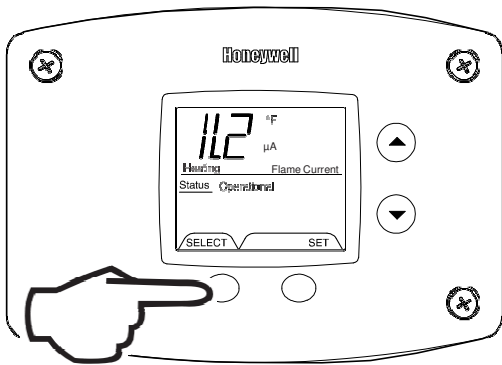

Fig. 33

3. Flame Current of Pilot Flame Sensor (Displays only in the Heating Cycle) (Fig. 33).

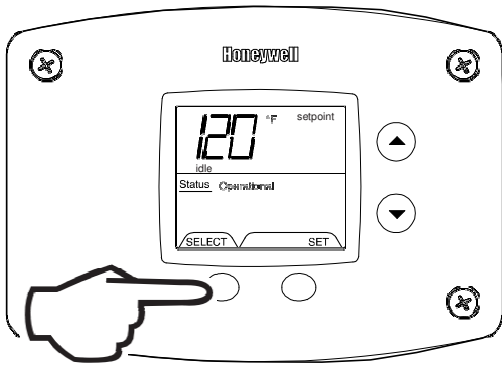

Fig. 34

4. Setpoint (Display/Change) (Fig. 34).

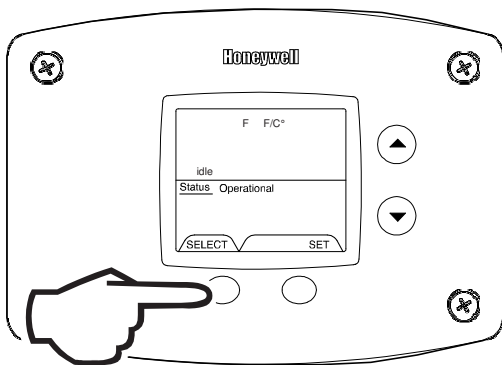

Fig. 35

5. °F/°C (Display/Change) (Fig. 35).

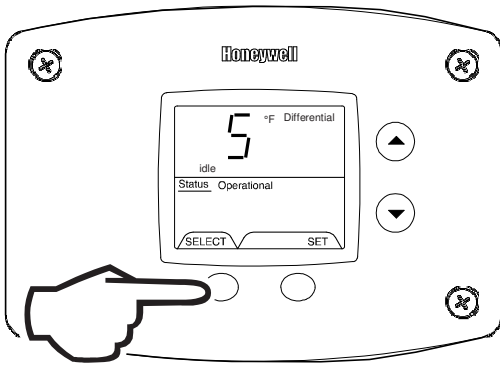

Fig. 36

- 6. Differential (Display only – shows the differential of the thermostat) (Fig. 36).

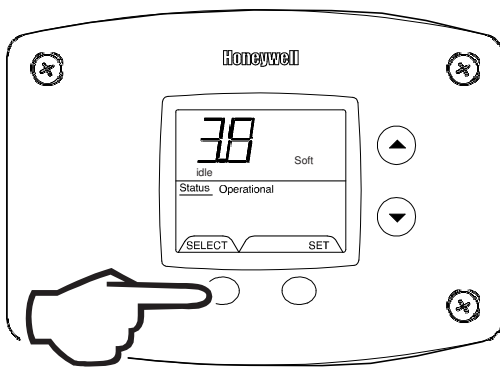

Fig. 37

- 7. Software Version (Display only) (Fig. 37).

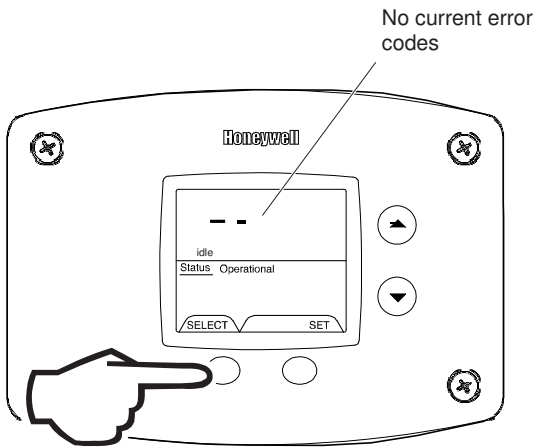

Fig. 38

- 8. Error Code History (Displays if there are present error codes or up to 10 previous error codes). Water Heater Display will show -- if there are no error codes (Fig. 38).

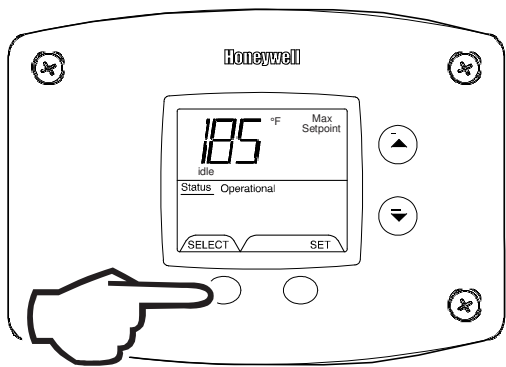

Fig. 39

'Max Setpoint' flashes

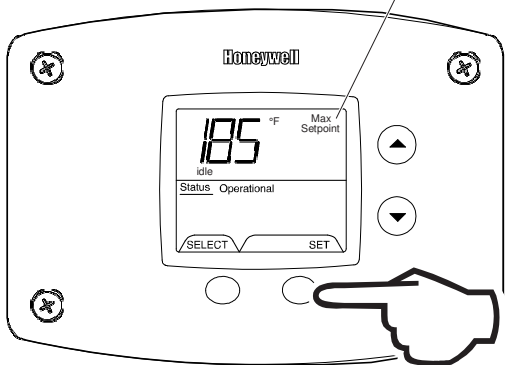

Fig. 40

'Max Setpoint' continues to flash while making adjustments

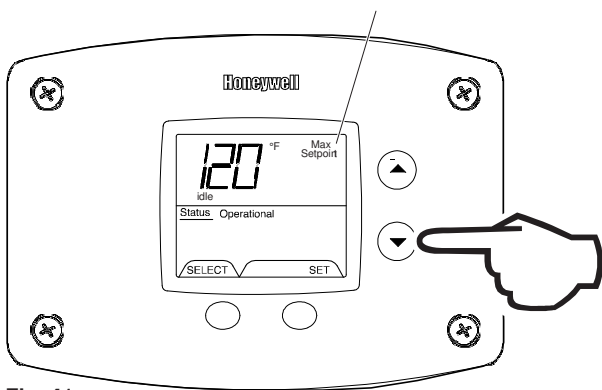

Fig. 41

'Max Setpoint' stops flashing

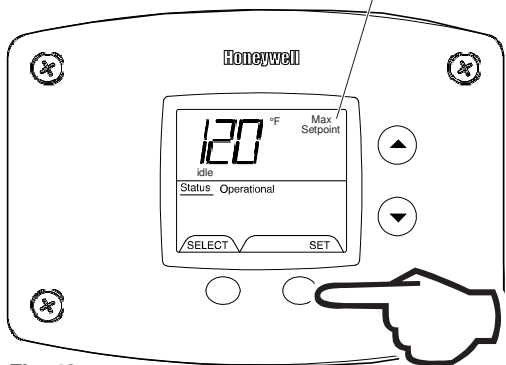

Fig. 42

6.6.2 To change the Maximum Setpoint Limit (Max Setpoint) for the temperature setpoint

Warning
 Setting the water temperature to the maximum set point can result in scalding hot water delivered to the domestic hot water outlets. It is highly recommended that the maximum setpoint be adjusted to the lowest temperature possible for the needs of the installation. See following section to change the maximum setpoint limit (max setpoint). Make sure the water heater control display is not in a public area that can result in the temperature settings being improperly adjusted.

1. In service mode press the 'Select' button until 'Max Setpoint' is displayed (Fig. 39).
2. Press 'Set' button to enter setting mode. 'Max Setpoint' will flash to indicate setting mode (Fig. 40).
3. Press the 'UP' or 'DOWN' buttons to change the maximum setpoint value. This will limit the maximum setpoint the user can select. Note: The maximum setpoint is approximately 82C (Fig. 41).
4. Press 'Set' button to confirm new 'Max Setpoint' value and stop setting mode (Fig. 42).

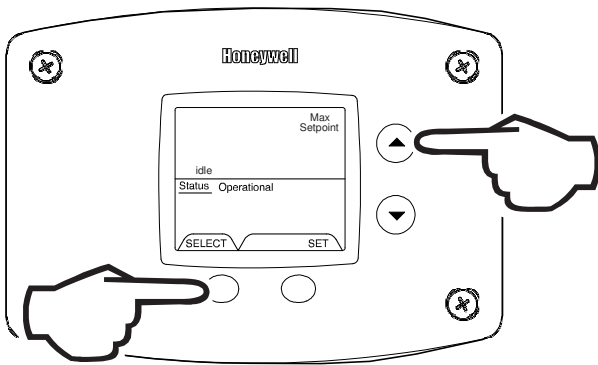

Fig. 43

- 30 Seconds after the last button press, the Water Heater Display will go back to 'User Mode'. It will read 'Max Setpoint' without showing a temperature value if the temperature setpoint is at the maximum setting. The Water Heater Display can be set back to the 'User Mode' immediately by pressing both the 'Temperature Up' and 'Select' buttons together for 3 seconds (Fig. 43).

6.6.3 Display of water temperature

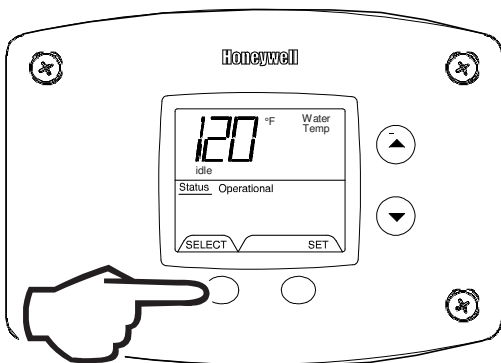

Fig. 44

- In Service Mode, Press the 'Select' button until 'Water Temp' is displayed in the upper right section of the water heater display. For water heaters using two temperature sensors in the tank, this will be the average reading between the two sensors. For water heaters using a single sensor, this is the reading for the sensor (Fig. 44).

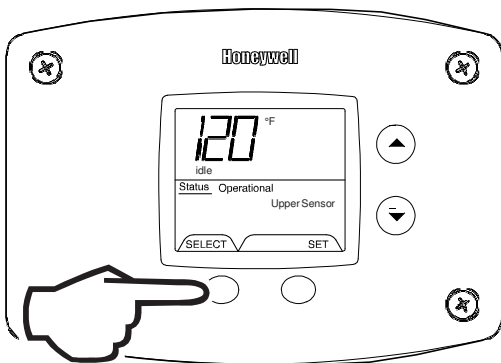

Fig. 45

- For water heaters using two temperature sensors, pressing the 'Select' button again displays the Upper Sensor temperature reading. 'Upper Sensor' will be displayed in the lower right side of the status window of the water heater display (Fig. 45).

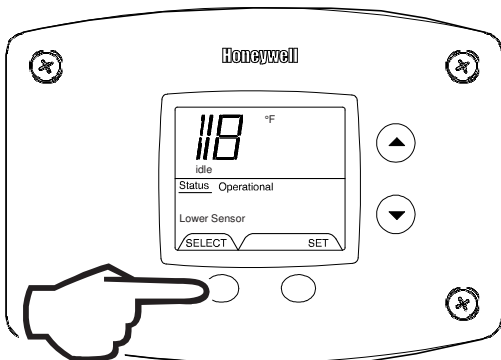

Fig. 46

- For water heaters using two temperature sensors, pressing the 'Select' button again displays the Lower Sensor temperature reading. 'Lower Sensor' will be displayed in the lower left side of the status window of the water heater display (Fig. 46).

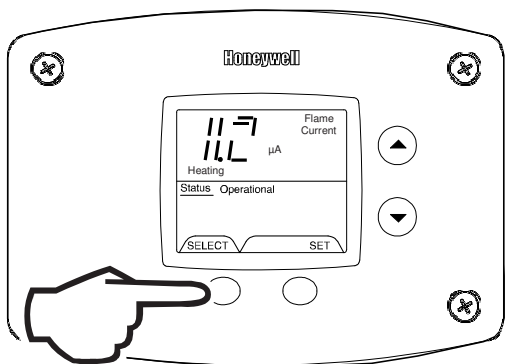

Fig. 47

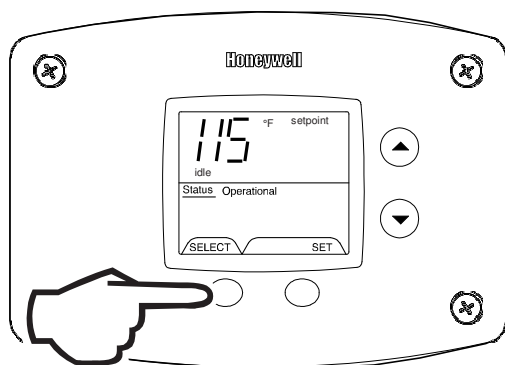

Fig. 48

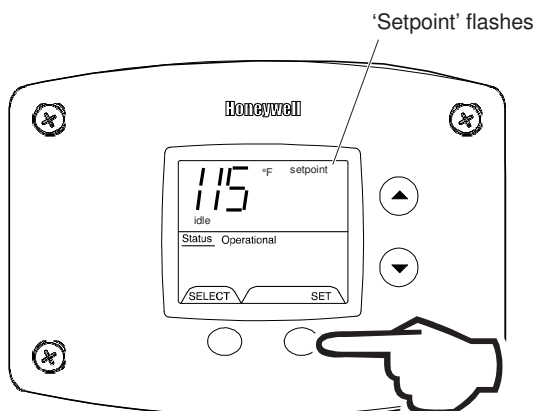

Fig. 49

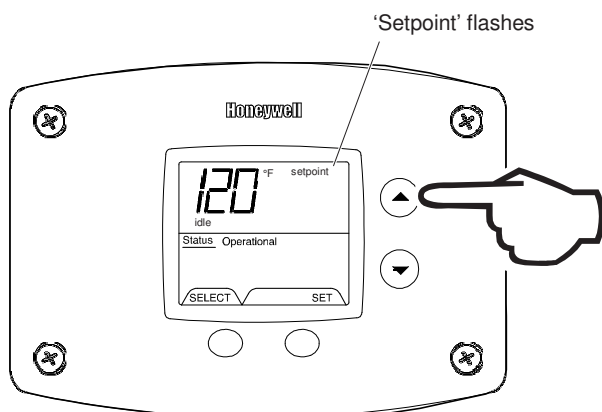

Fig. 50

6.6.4 To display flame sense current of the pilot flame sensor

The pilot flame sense current is available only when the burners are in operation.

1. Make sure the status displays 'Heating' or draw enough hot water to start the burners.
2. Enter the 'Service Mode' described previously.
3. Press the 'Select' button until a number value is displayed with 'Flame Current' to the right of the number. The value displayed is in microamps (μA). (Fig. 47)

6.6.5 To display and change temperature setpoint

1. In 'Service Mode' press the 'Select' button until 'Setpoint' is shown in the water heater display (Fig. 48).

2. Press the 'Set' button to enter the setting mode. 'Setpoint' will flash in the water heater display (Fig. 49).

3. To raise the temperature setpoint, press the 'Temperature Up' button until the desired temperature is shown on the water heater display (Fig. 50).

Note
The maximum temperature that can be set in the Water Heater Display is limited to the 'Max Setpoint' described previously. To change the 'Max Setpoint', refer to the procedure 'To Change the Maximum Setpoint Limit...' described previously under 'Accessing the Service Mode on the Water Heater Display'.

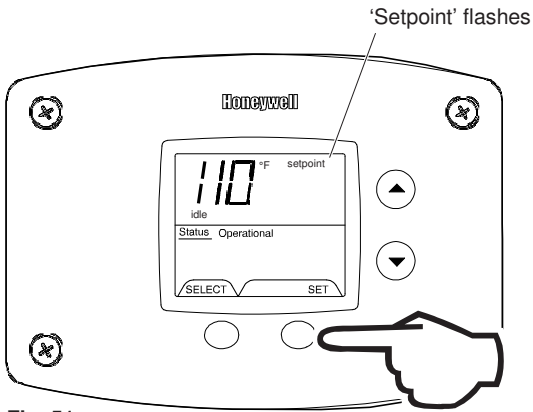

Fig. 51

- To lower the temperature setpoint, press the 'Temperature Down' button until the desired temperature is shown on the water heater display (Fig. 51).

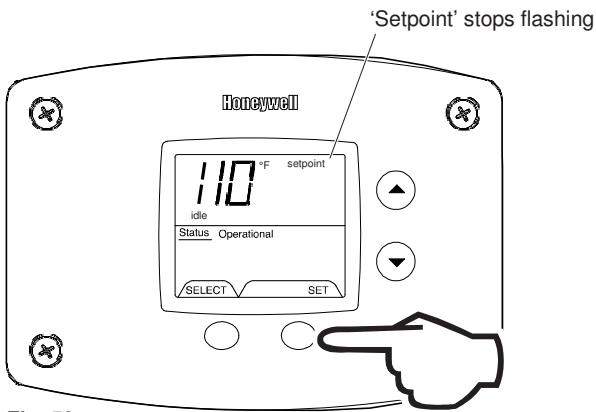

Fig. 52

- When the desired setpoint is reached on the water heater display, press the 'Set' button to confirm the new setpoint. 'Setpoint' stops flashing in the water heater display (Fig. 52).

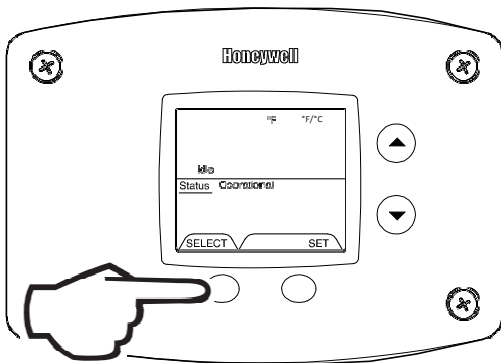

Fig. 53

6.6.6 To display and change temperature format (°F/°C)

- While in 'Service Mode', press 'Select' button until '°F/°C' is shown in the upper right portion of the water heater display (Fig. 53).

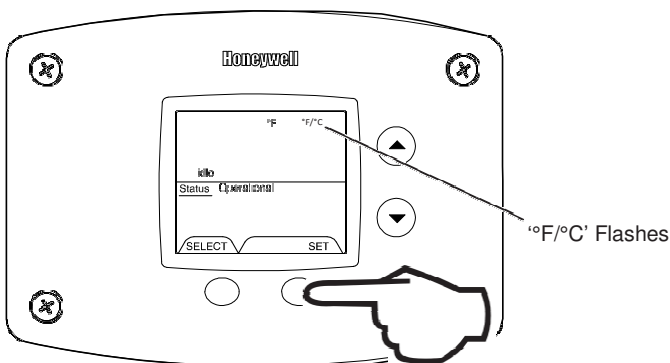

Fig. 54

- Press 'Set' button to change temperature format. '°F/°C' symbol will flash in the water heater display (Fig. 54).

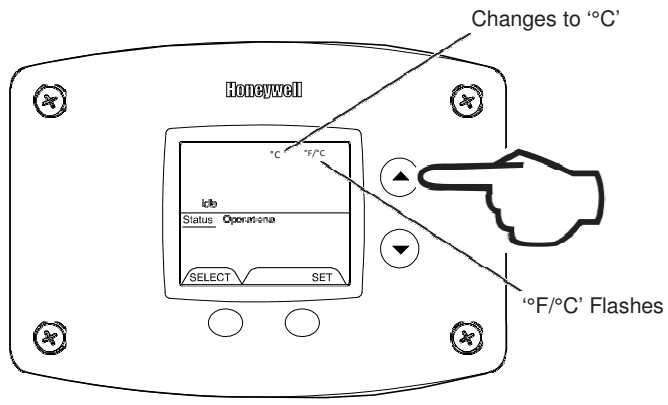

Fig. 55

3a. Press 'Temperature Up' button to change temperature format to °C (Fig. 55).

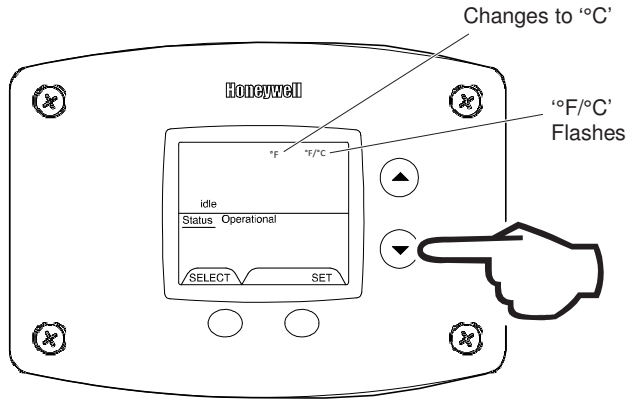

Fig. 56

3b. Press 'Temperature Down' button to change temperature format to °F (Fig. 56).

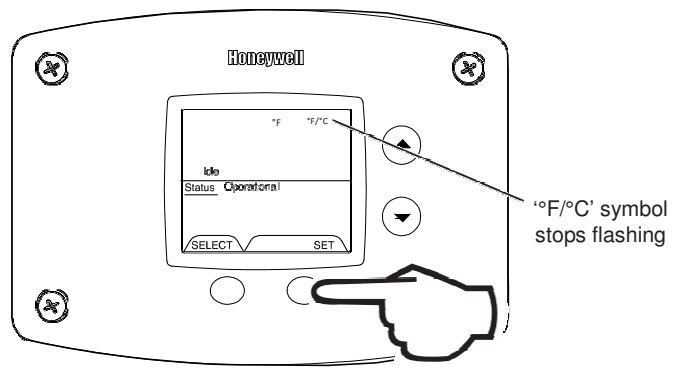

Fig. 57

4. Press 'Set' button to confirm °F or °C format. °F/°C will stop flashing (Fig. 57).

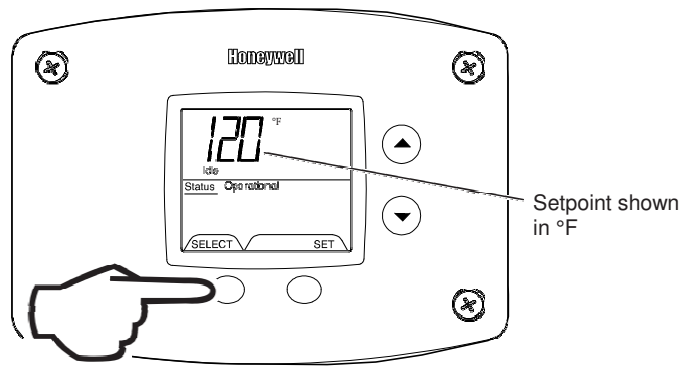

Fig. 58

5. Pressing 'Select' button will return display to setpoint in format selected (°F or °C) immediately (Fig. 58).

6.7 How to reset the control from Lockout conditions



Warning

The following procedure is for service and installation personnel only. Resetting lockout conditions without correcting the malfunction can result in a hazardous condition.

If an error code is displayed (except for #4, low flame sense current), the water heater will be in a 'lockout condition' with the water heater display showing the error code number and 'Service Needed' in the status section of the display window.

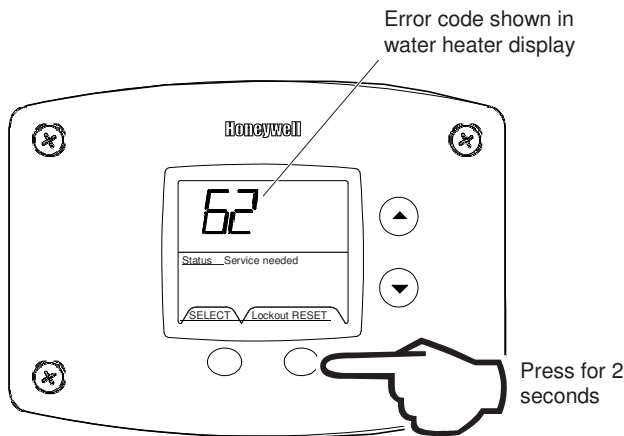

Fig. 59

6.7.1 Resetting error codes in soft lockout condition

Error codes 62 (maximum number of retries detected) and 63 (maximum number if ignition recycles detected) are 'Soft Lockouts' in which the control can be reset in the 'User Mode' by pressing the lower right button under 'Lockout Reset' shown in the lower right portion of the display (Fig. 59). The control will also go through 3 attempts to relight the burners every hour in the soft lockout condition.

6.7.2 Resetting error codes in hard lockout condition

All other error codes will put the water heater into a 'Hard Lockout' condition, in which the water heater will not operate and cannot be reset in the 'User Mode'. To reset a hard lockout, first enter the "Service Mode" described earlier by pressing both the 'Temperature Up' and 'Select Buttons' at the same time for 3 seconds. Then press the lower right button under 'Lockout Reset' in the water heater display and hold for 3 seconds.

1. Press for 3 seconds to enter service mode (Fig. 60).

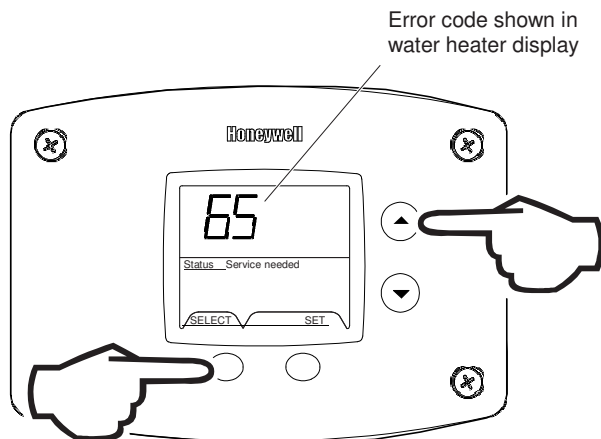

Fig. 60

2. Press for 3 seconds to reset control in service mode (Fig. 61).

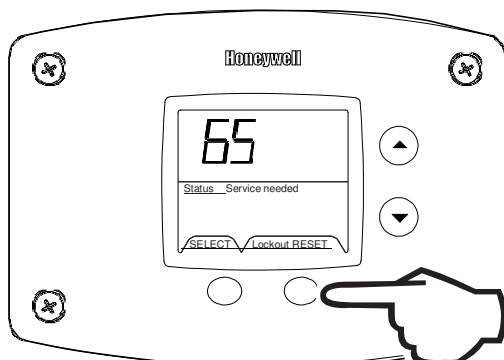

Fig. 61

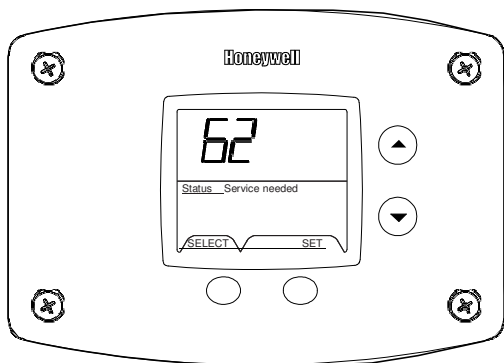

Fig. 62

--

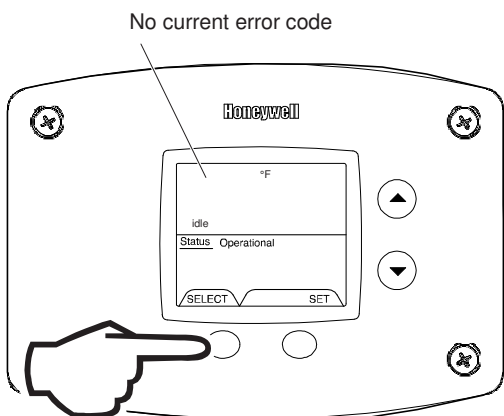

Fig. 63

Error code index

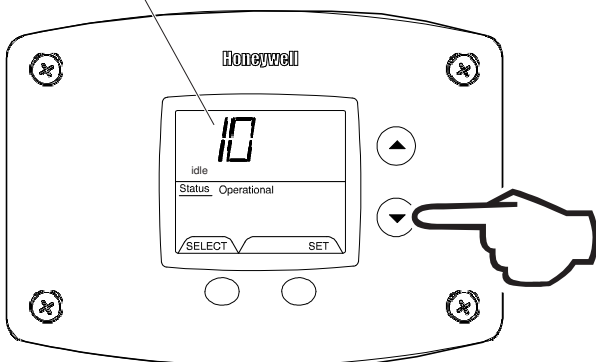

Fig. 64

No error code shown for code index 10

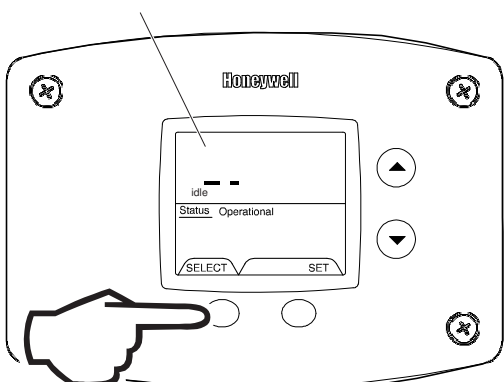

Fig. 65

6.7.3 Error codes and error history display

If there is an operating problem with the water heater, an error code number will appear on the water heater display with 'Service Needed' to the right of the 'Status' indicator. The error code label is located below the water heater display and the following section in this Installation and Operating Instruction Manual explains the error codes with corrective actions to repair the water heater. Example of Error Code in the Display (Fig. 62).

6.7.4 Error code history

In 'Service Mode' pressing the 'Select' button after the 'Software Version' (item 8 in the previously described sequence of service modes) will show an error code history, if there have been any previous operating problems with the water heater. If the display shows --, there is not a current error code.

The Water Heater Display will provide up to 10 previous error codes. The oldest error code will be stored in code index #1 and the most recent in code index #10 (if there are 10 error codes).

6.7.5 To view previous error codes

1. In 'Service Mode' press the 'Select' button until the next display after the 'Software Version'. If there are no current error codes, the display will show -- (Fig. 63).
2. Press the "Temperature Down" button to select the error code index, starting with the most recent error code '10' (Fig. 64).
3. Press the "Select" button to view the error code for 'code 10'. If there is a number displayed, note what the number is. The label next to the water heater display will identify the code number. If no number is displayed with only a '--' in the water heater display, then there has not been an error code for error code index 10 (Fig. 65).

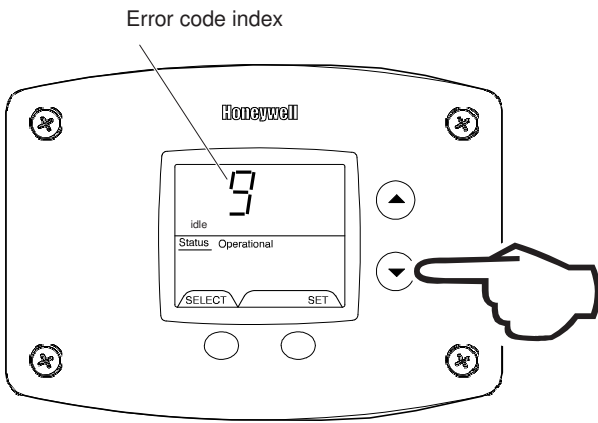

Fig. 66

4. Press the 'Temperature Down' button to change to the previous code index, code #9 (Fig. 66).

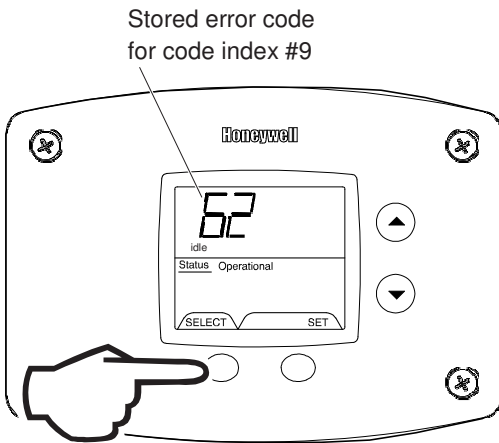

Fig. 67

5. Press the 'Select' button for code index #9 to view if there are any code numbers (Fig. 67).
6. Continue pressing the 'Temperature Down' button to change to the next error code index and press 'Select' to view the error code number, if any, for that index number. Continue on to index #1, the oldest error code index. The water heater display will store up to 10 error codes with the oldest code starting in code index #1 with the most recent code in code index #10.

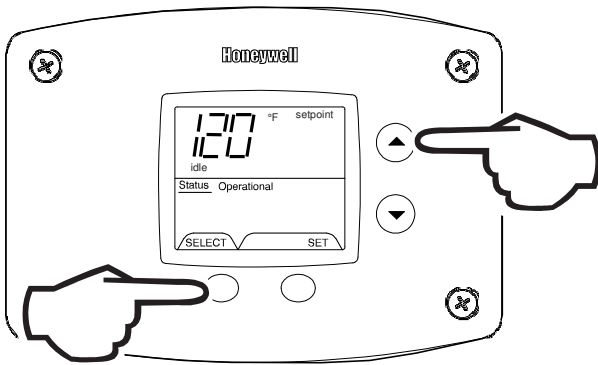

Fig. 68

7. 10 seconds after the last button press, the Water Heater Display will revert back to the current error code display. To exit Service Mode, either wait 30 seconds or press Temperature Up button and Select Button for 3 seconds (Fig. 68).

6.8 Diagnostic error codes and troubleshooting procedures for Honeywell integrated control

Error code	Definition of code	Cause of problem and actions taken to correct
4	Low flame sense	Determine flame sense current in the Service mode with the water heater operating. If less than 1.0 microamps, check pilot flame sense rod with emery cloth. If problem is not solved, replace pilot.
6	Flame sensed out of normal sequence (before opening gas valve or after closing gas valve)	Check to make sure gas valve has closed. No voltage should be present at the gas valve before or after ignition cycle. Make sure wire positions on the wire harness are correct. If gas valve is stuck open, replace.
23	Flame detected before ignition	Check to make sure gas valve has closed. No voltage should be present at the gas valve before the ignition cycle. Make sure wire positions on the wire harness are correct. If gas valve is stuck open, replace.
24	Flame detected after heating cycle completes	Check to make sure gas valve has closed. No voltage should be present at the gas valve before the ignition cycle. Make sure wire positions on the wire harness are correct. If gas valve is stuck open, replace.
31	Upper sensor reading faulty	Resistance of upper sensor out of operating range. Check continuity of wire harness to upper sensor, and if O.K., replace upper sensor.

Error code	Definition of code	Cause of problem and actions taken to correct
32	Lower sensor readings faulty	Resistance of lower sensor out of operating range. Check continuity of wire harness to lower sensor, and if O.K., replace lower sensor.
57	Flame rod shorted to ground	Pilot flame sensor rod is shorted to ground. Check to see if flame sensor wire has bare spots touching metal parts or if flame sensor rod is touching the pilot shield or other metal parts. Replace pilot if flame sense wire is damaged or flame rod is bent.
58	AC line frequency error – Signal too noisy or frequency incorrect	Check line voltage frequency to the water heater. Determine if there are wide fluctuations. Call an electrician if the problem persists. The water heater should be on a separate line.
59	Line voltage too low or high	Check line voltage to the water heater. Determine cause of low or high voltage. Call an electrician or your utility. The water heater should be on a separate line.
61	DC output voltage unstable	Check line voltage to the water heater for erratic readings. Also check wiring to make sure there are no shorts. If power supply and wiring is O.K., replace control board.
62	Maximum number of retries detected	Pilot is either not lighting or not staying lit during the ignition cycle. Check inlet gas pressure for minimum pressure on rating label. Is pilot electrode sparking? Check gas valve wire harness for broken wires or shorts. If 24 volts is present between PV and PV/MV terminals at the gas valve, replace gas valve. Check for voltage output to the yellow and red gas valve wires on the control board pins. If during the ignition trial period, there is no voltage present at the control board pin terminal for the red and yellow wires leading to the gas valve, then replace the control board. Replace pilot if wires are damaged or electrode is damaged.
63	Maximum number of ignition recycles detected	Pilot flame is lost during run cycle, then reestablished on ignition cycle. Check inlet gas pressure. Is gas pressure dropping below the minimum operating pressure on the rating label after the main gas valve opens? Is the gas pipe size to the water heater adequate? Check the pilot shield position and condition of the burners. Clean or replace as needed. Check the pilot flame and observe the microamp output on the run cycle. Check the pilot tubing to the pilot and replace if crimped or damaged. Replace pilot if wires, flame sensor, or electrode is damaged.
64	Electronics Failure	Replace control board.
65	High Water Temperature (Over 93°C)	Water temperature in tank has exceeded 93°C. Check lower sensor. Make sure sensor is fully inserted into the well (clip on sensor wire secures sensor in place). Check lower and upper (where used) sensor readings. If not within specifications, replace sensor. If sensor and wire harnesses check O.K., replace control board.

7 Fault Finding

7.1 Andrews 20/190

Fault	Action
NO IGNITION AT PILOT	(a) Power to unit interrupted (b) Thermostat faulty (c) Spark ignition control module faulty
FLUE FAN RUNS NO IGNITION SPARK	(a) Faulty air pressure switch (b) Faulty spark ignition lead
FLUE FAN DOES NOT RUN	(a) Power to unit interrupted (b) Faulty fan motor (c) Flue fan ECO actuated
HEATER WILL NOT LIGHT LOCKOUT ALARM ILLUMINATED	(a) Check gas service cock is open Press reset button Check action of flue fan ECO. If this switch is Actuating check:
MAIN BURNER OUTAGE AT PERIODIC INTERVALS	(a) Sufficient ventilation is provided (b) The resistance of the flue system is too high (c) The burner pressure is too high (d) The flue fan ECO is faulty
WATER TEMPERATURE TOO HIGH	(a) Reset thermostat to lower temperature. (b) Thermostat faulty. Check and replace if necessary. (c) Main gas valve not closing. Clean or replace.
WATER TEMPERATURE TOO LOW	(a) Reset thermostat to higher temperature. (b) Check gas pressures at burner and at gas inlet to heater. (c) Thermostat faulty. Check and replace if necessary.
NOT ENOUGH HOT WATER	(a) Check gas pressures at burner and at gas inlet to heater. (b) Check amount of water being used against recovery rate given on data plate. If usage too high, more heating capacity needed.
WATER DRIPPING FROM BASE OF HEATER	(a) Check if this stops when water in heater is hot. If yes, then condensation is the problem caused by incorrectly designed flue or by tank cooling excessively, i.e. more hot water being used than recovery rate of heater. If so, more heating capacity needed. (b) If water continues to drip when heater is hot, problem is leaking joint or storage vessel.
RUMBLING NOISE	(a) Scale formation in heater, consult water treatment specialist. Heater must be descaled and suitable water treatment provided to avoid re-occurrence.

8 Parts List

8.1 General Assembly

Fig. 69

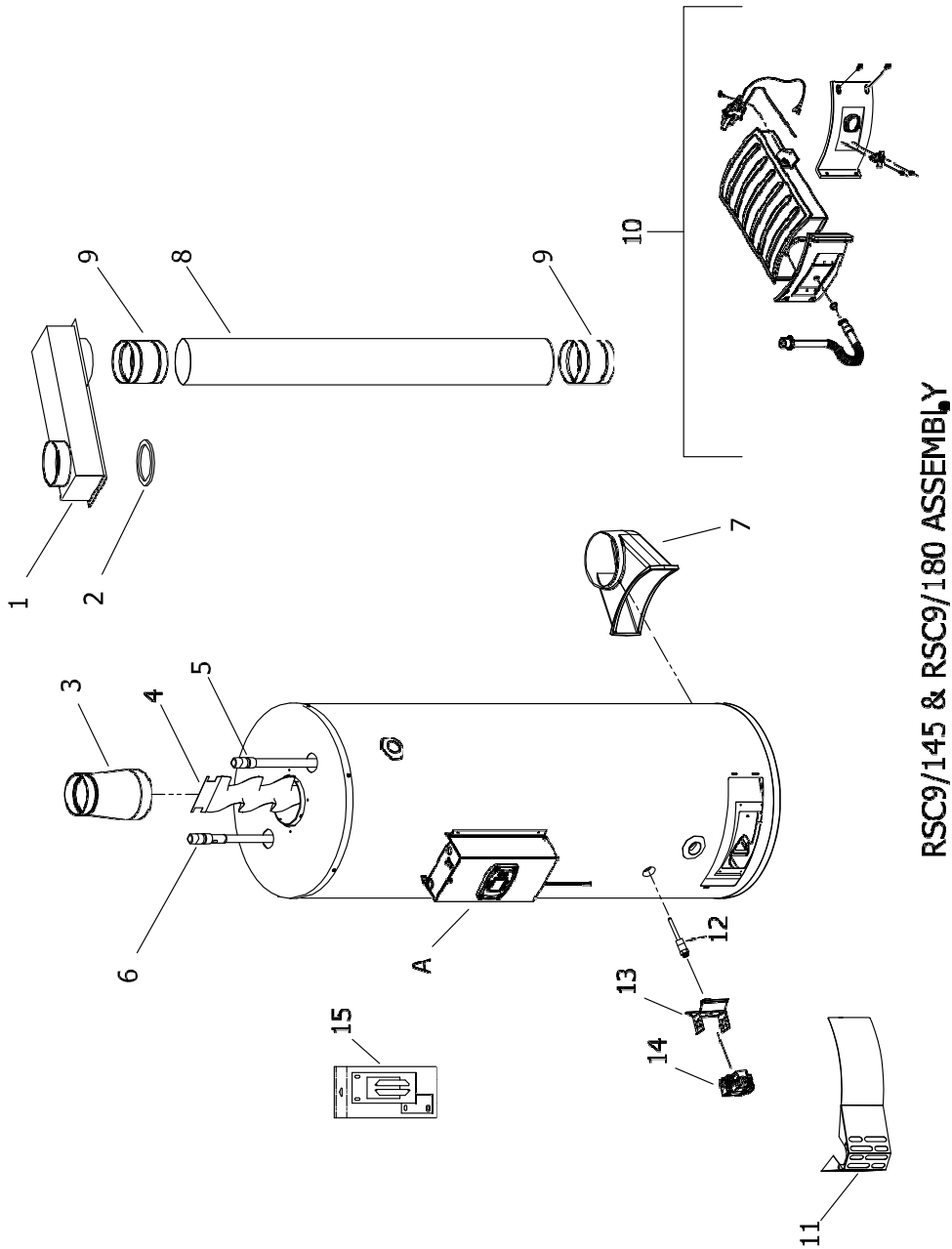

RSC9/145 & RSC9/180 ASSEMBLY

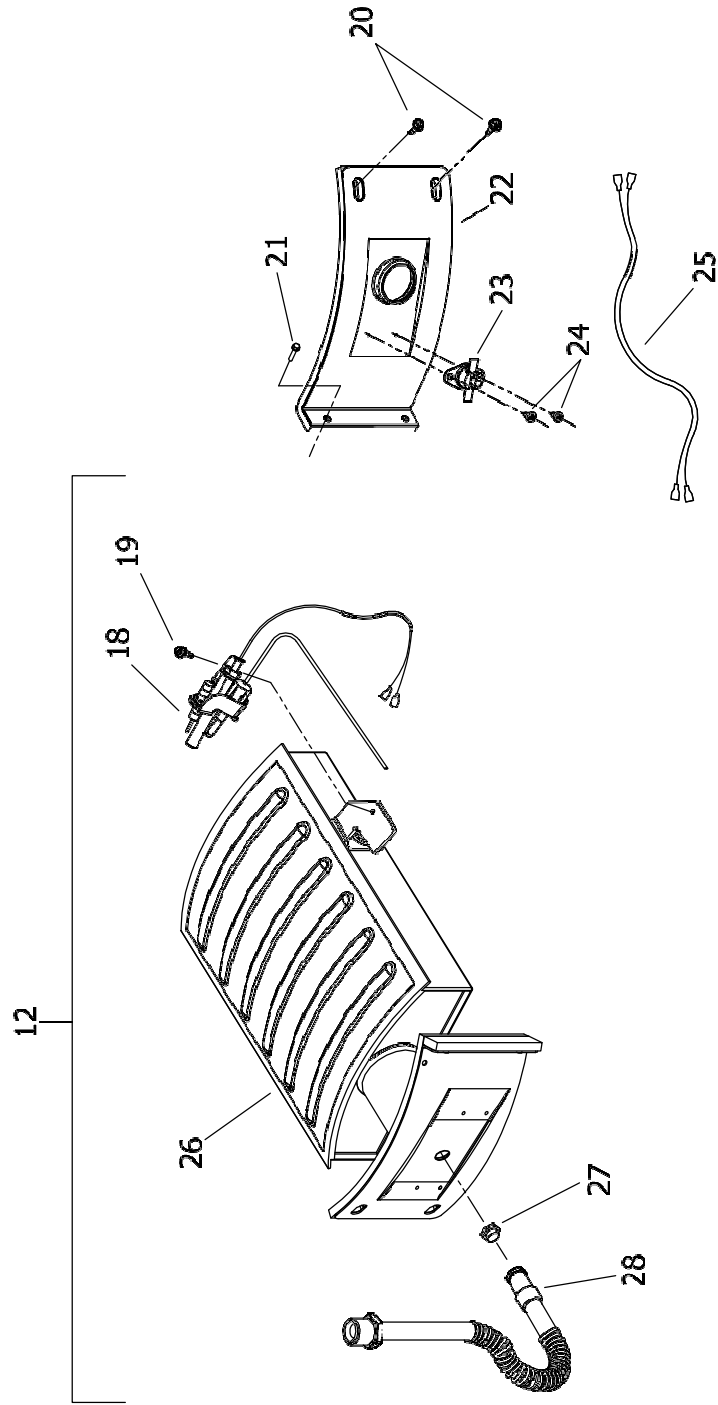

RSC9/145 & RSC9/180 NATURAL GAS (N) BURNER ASSEMBLY

8.2 Control Box Assembly

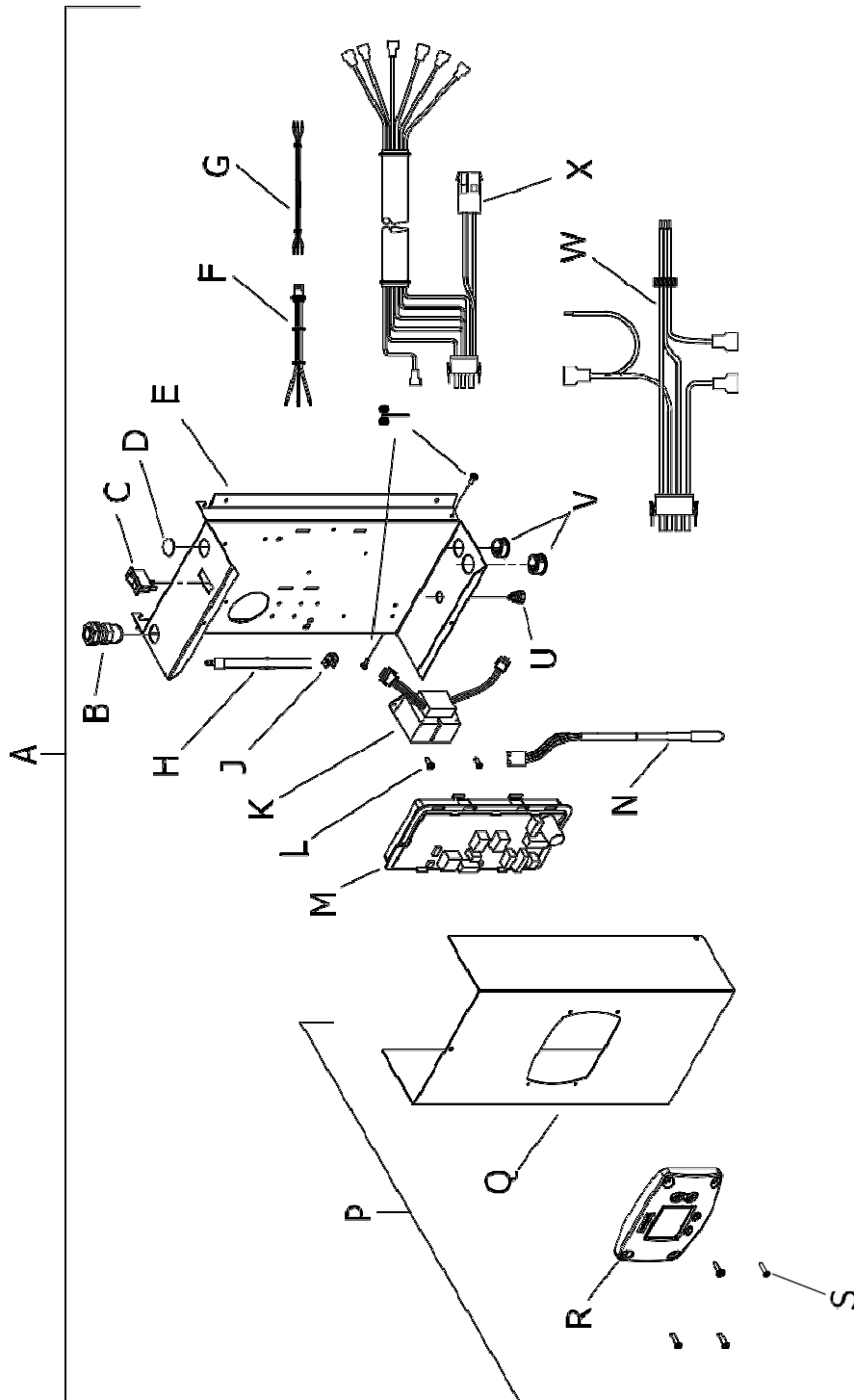

RSC9/145 & RSC9/180 CONTROL BOX ASSEMBLY

8.3 General Assembly Parts List

General Assembly					
No.	Part No.	Description	Qty	RSC9/145	RSC9/180
1	7704029	Plenum	1	•	•
2	7678672	Plenum Gasket	1	•	•
3	7704031	Flue Reducer	1	•	•
4	7704030	Flue Baffle	1	•	
4	7704032	Flue Baffle	1		•
5	7703865	Cold Water Inlet Dip Tube	1	•	
5	7703992	Cold Water Inlet Dip Tube	1		•
6	7703991	Hot Water Outlet Anode (Mag)	1	•	•
7	7703994	Air Intake Boot w/c Gasket	1	•	•
8	7703993	Air Intake Tube	1	•	
8	7703877	Air Intake Tube	1		•
9	7703881	Coupler	2	•	•
10	See Burner	Burner Assembly	1	n/a	n/a
11	7703994	Outer Door	1	•	•
12	7703993	Brass Sensor Well	1	•	•
13	7678973	Gas Valve Bracket	1	•	•
14	7678972	Gas Valve (Nat Gas)	1	•	•
15	7703877	Inner Door	1	•	•

Burner Assembly					
No.	Part No.	Description	Qty	RSC9/145	RSC9/180
12	7704037	Burner Assy Complete (Nat Gas)	1	•	•
18	7703881	Gas Pilot Assembly	1	•	•
19	Z194	Screw 18 x 1/2	2	•	•
20	7703882	Screw 12 x 3/4	5	•	•
21	7703889	Screw 18 x 3/4	2	•	•
22	7704038	Right Side Inner Door Assy	1	•	•
23	7704039	Thermal Switch	1	•	•
24	7703902	Screw 20 x 3/8 PHCR	2	•	•
25	7704040	Thermal Switch Harness	1	•	•
26	7704041	Gas BN Burner	1	•	•
27	7704042	Main Burner Orifice	1	•	•
28	7704043	Universal Flex Feedline	1	•	•

Control Panel					
No.	Part No.	Description	Qty	RSC9/145	RSC9/180
A	7704044	Control Box Assy (Single Sensor)	1	•	•
B	Z256	Liquid Tight Fex Cord Fitting	1	•	•
C	Z143	Power on/off Switch	1	•	•
D	Z262	Snap-in Plug	1	•	•
E	Z258	Control Box Panel	1	•	•
F	Z255	IC Board Display Harness	1	•	•
G	Z270	Alarm Module Harness	1	•	•
H	Z271	Noise Supp. Capacitor	1	•	•
J	Z261	Terminal ES-4	1	•	•
K	7703915	Transformer	1	•	•
L	Z305	Screw 18 x 1/2 Pan Head	2	•	•
M	Z138	Intergrated Control Board (single Sensor)	1	•	•
N	Z122	Temperature sensor Wire Harness	1	•	•
P	Z265	Control Box Cover Assembly	1	•	•
Q	Z472	Control Box Cover	1	•	•
R	Z140	Honeywell Temperature Control Display	1	•	•
S	Z266	Screw 18 x 3/4 Pan Head	4	•	•
T	7703916	Screw 18 x 5/16	2	•	•
U	Z264	Strain Relief Bushing 1/2"	1	•	•
V	Z257	Snap-in Bushing 7/8"	2	•	•
W	Z251	Power Harness	1	•	•
X	7678981	Gas Valve Control Wiring Harness	1	•	•

Fittings Pack					
No.	Part No.	Description	Qty	RSC9/145	RSC9/180
	7697191	Fittings Pack	1	•	•
	C382AWH	Gas Cock 1/2"	1	•	•
	C381AWH	Water Cock 3/4"	1	•	•
	C103AWH	Socket 3/4"	1	•	•
Flue Components					
D1	E072	Heater Adaptor	1	•	•
D2	E069	Flue 0.5 M	1	•	•
D3	E073	Horizontal Terminal c/w Wall Plates	1	•	•
D4	E071	Bend 90°	1	•	•
D5	E067	Vertical Terminal	1	•	•
D6	E075	Clamp c/w Seal	1	•	•
D7	E074	Flue Restrictor 45mm Vertical	1	•	
D7	E076	Flue Restrictor 60mm Horizontal	1	•	
D7	E077	Flue Restrictor 48mm Vertical	1		•
D7	E078	Flue Restrictor 50mm	1	•	
D7	E107	Flue Restrictor 55mm	1		•
D8	E065	Roof Plate	1	•	•
D9	E066	Roof Plate Angled	1	•	•
D10	E105	Horizontal Flue Outlet Guard	1	•	•
Fittings Pack					
	B167	Fittings Pack	1	•	•
	C382AWH	1/2" Gas Cock	1	•	•
	C381AWH	3/4" Water Cock	1	•	•
	C103AWH	3/4" Socket	1	•	•
BMS Interface Kit					
	7705367	BMS Interface Kit	1	•	•
	7705307	Correx Kit	1	•	•
Unvented Kit					
	7703928	Unvented Kit	1	•	•
	7705036	Pressure Reducing /Check/Expansion Valve	1	•	•
	7705037	Expansion Vessel 24L	1	•	•
	7705038	T/P Relief Valve 7 bar/95°C x 3/4"	1	•	•
	7705039	Tundish	1	•	•
	7705040	Adaptor 3/4"	1	•	•
	7705041	Hose Assy	1	•	•
	7705042	Pressure Reducing Valve Cartridge	1	•	•
	7705043	Expansion Valve Cartridge (Spare)	1	•	•

9 Appendix

9.1 Dismantling, Disposal and Recycling

**Warning**

Only qualified competent persons should remove and dismantle the appliance.

Before removing and dismantling please ensure you safely remove the power supply and isolated the appliance from the water and gas connections.

Dispose of the appliance correctly according to the laws and regulations in force. The appliance and accessories cannot be discarded along with normal household waste and should be recycled where appropriate.

More than 90% of the materials that make up the appliance are recyclable.

© Copyright

All technical and technological information contained in these technical instructions, as well as any drawings and technical descriptions supplied, remain our property and shall not be multiplied without our prior consent in writing. Subject to alterations.



Register now to activate your warranty www.andrewswaterheaters.co.uk/warranty
Please make sure you attach proof of purchase for your warranty to be monitored.

All descriptions and illustrations provided in this document have been carefully prepared but we reserve the right to make changes and improvements in our products which may affect the accuracy of the information contained in this leaflet. All goods are sold subject to our standard Conditions of Sale which are available on request.

February 2018

Customer support
Monday - Friday
8am - 5pm

Sales
0345 070 1055
Technical
03450701057
Website
andrewswaterheaters.co.uk
Twitter
@AndrewsWH



Andrews. Built to perform

