

OWNER'S GUIDE

## GAS WATER HEATER

WHi49, LWHi49, WHiC56, LWHiC56 (Internal)

WHiX49, LWHiX49, WHiXC56, LWHiXC56 (External)

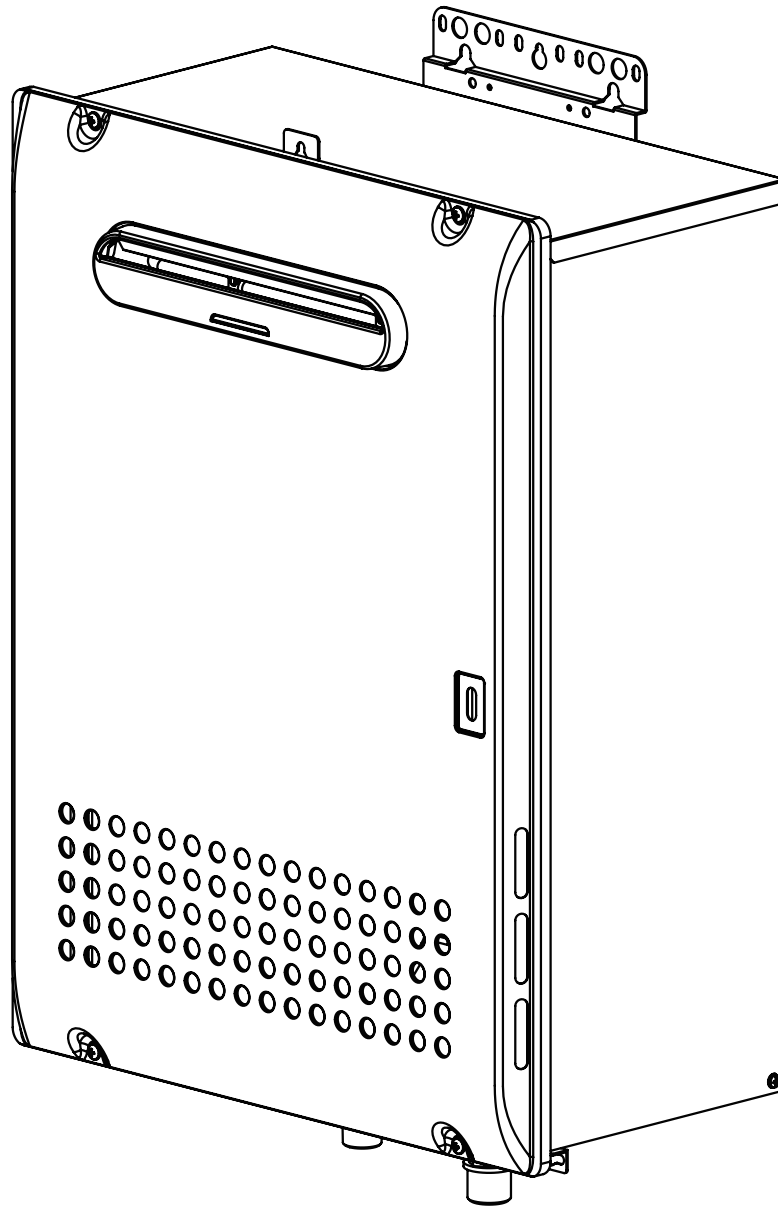

SBB80Z5

Please read and understand these instructions before commencing installation and leave this manual with the customer for future reference.

**Andrews. Built to perform.**



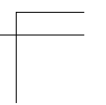
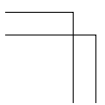
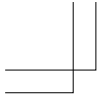

# Owner's Guide

Models: WHi49, LWHi49, WHiC56, LWHiC56  
WHiX49, LWHiX49, WHiXC56, LWHiXC56

**WARNING:** If the information in this manual is not followed exactly, a fire or explosion may result causing property damage, personal injury or death.

- Do not store or use gasoline or other flammable vapors and liquids in the vicinity of this or any other appliance.

**- WHAT TO DO IF YOU SMELL GAS**

- Do not try to light any appliance.
- Do not touch any electrical switch; do not use any phone in your building.
- Immediately call your gas supplier from a neighbor's phone. Follow the gas supplier's instructions.
- If you cannot reach your gas supplier, call the fire department.

- Installation and service must be performed by a qualified installer, service agency or the gas supplier.

Thank you for purchasing this ANDREWS WATER HEATERS Condensing Gas Water Heater. Before using, please: Read this manual completely for correct installation and operation instructions. Keep this manual where it can be found whenever necessary.

**AGENT : ANDREWS WATER HEATERS**

Innovation House 3 Oaklands Business Centre Oaklands Park Wokingham Berkshire RG41 2FD, UK

**PRODUCT : NORITZ Corporation**

5, Minamifutami, Futami-cho, Akashi, Hyogo, Japan

# Contents

Contents.....	2
Owner's Guide	
Important Safety Information .....	3
Overview of Condensing Gas Water Heater .....	7
RC-9018C <Optional> Operation Overview .....	8
General Parts	
Main Unit.....	10
Names and Functions of Controllers .....	13
Initial Operation.....	15
System Check.....	16
How to Use	
[For All Systems]	
Using the Water Heater .....	18
Setting Hot Water Temperature .....	19
Automatic Water Heater "ON" or "OFF" Operation.....	20
Locking the Remote Controller.....	22
Clock Adjustment.....	23
Customizable Settings <Misc settings>.....	24
[For System[Rcrc]]	
Enabling Automatic Recirculation Operation.....	28
Manually Starting Recirculation Operation .....	29
Setting the Recirculation System Operation Timer.....	30
[Single Water Heater Only]	
Flow Meter Alarm .....	32
Preventing Damage from Freezing.....	34
When Unused for an Extended Period .....	35
Regular Maintenance .....	37
Troubleshooting .....	40
Follow-up Service .....	45
Specifications.....	47
Default Settings.....	53
Water Quality .....	53
Maintenance .....	54



# Important Safety Information-1

To prevent damage to property and injury to the user, the icons shown below will be used to warn of varying levels of danger.

Every indication is critical to the safe operation of the water heater and must be understood and observed.

Potential dangers from accidents during installation and use are divided into the following three categories. Closely observe these warnings; they are critical to your safety.

## Icons warning of risk level

	<b>Danger</b>	Denotes content that may result in instantaneous fire, serious injury and even death when ignored.
	<b>Warning</b>	Denotes content that may result in fire, serious injury and even death when ignored.
	<b>Caution</b>	Denotes content that may result in bodily injury and physical damage when ignored.
<b>Remarks</b>	The content following this icon is necessary to understand for safe and easy use of this water heater.	

## Other icons

	Electric Shock.		High Temperature.		Be sure to do.		Earth		
	Prohibited		No flame.		Don't touch.		Don't disassemble the equipment.		Don't touch with a wet hand.

** Danger**

 **If you detect a gas leak:**

1. Do not try to light any appliance
2. Do not touch any electrical switch; do not use any phone in your building.
3. Immediately call your gas supplier from a neighbor's phone. Follow the gas supplier's instructions.
4. If you cannot reach your gas supplier, call the fire department.

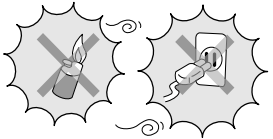

 **[Internal installation]**  
Do not use the water heater if the intake/exhaust pipe is displaced, has holes, or is corroded.

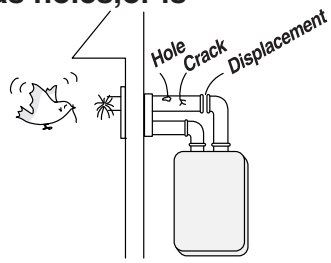

---

 **[External installation]**  
Do not install indoors.

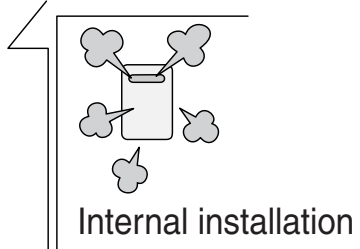

# Important Safety Information-2

## Warning



If you detect abnormal combustion or abnormal odors, or during an earthquake, tornado or fire:

1. Turn off the hot water supply.
2. Turn off the power to the water heater.
3. Turn off gas and water at the main.
4. Consult the nearest Andrews Water Heaters agent.



Check the temperature of the running hot water before entering the shower.



Check the temperature before stepping into the bath tub.

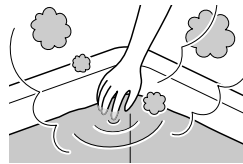

Do not turn off the water heater or change the water temperature while someone is using.



Be sure the gas/power supplied matches the gas on the rating plate.



Do not place or use a spray can near the heater or the exhaust vent terminal.



This appliance can be used by children aged from 8 years and above and persons with reduced physical, sensory or mental capabilities or lack of experience and knowledge if they have been given supervision or instruction concerning use of the appliance in a safe way and understand the hazards involved. Children shall not play with the appliance. Cleaning and user maintenance shall not be made by children without supervision.



Contact a qualified service technician for any necessary repairs, service or maintenance.



Contact Andrews Water Heaters before using with a solar pre-heater.



Do not place combustibles such as laundry, newspapers, oils etc. near the heater or the exhaust vent terminal.

Internal installation

External installation unit

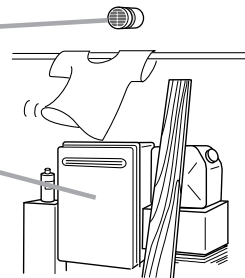

Do not use combustible chemicals such as oil, gasoline, benzene etc. in the vicinity of the heater or the exhaust vent terminal.



Leave the proper clearance between the water heater and nearby objects (trees, timber, boxes with flammable materials etc.).

### [Internal installation]

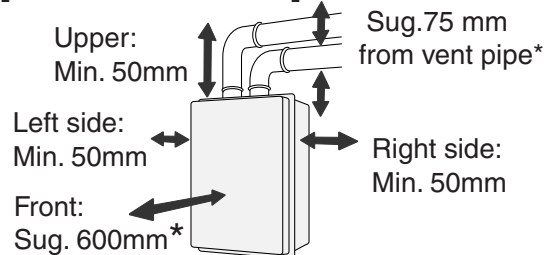

### [External installation]

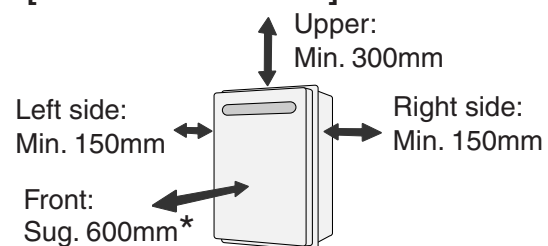

\* Indicates suggested clearances for maintenance.

## **Caution**



Be sure to electrically ground the unit.



Do not touch the power cord with wet hands.



Keep power cord free of dust.



Do not use a broken or modified power cord. Do not bind, bend or stretch power cords. Do not scratch, modify, or subject them to impact or force.



Do not use the water heater for other than hot water supply, shower and bath.



Do not use hair spray or spray detergent in the vicinity of the heater.



Do not touch the exhaust vent pipe during or immediately after operation of the water heater.

[Internal installation] [External installation]

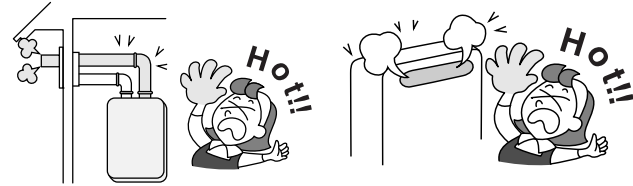

If this unit will be installed in a salon or other location where hair spray or aerosols will be used, locate the unit away from where these products are used.



Do not install in locations where excessive dust or debris will be in the air.



Do not use condensate, discharged from the drain pipe, for drinking or for consumption by animals.



To prevent burns or scalding, turn off the power on/off button and wait until the equipment cools before performing maintenance.

To prevent scalding.

The hot water in the equipment is a high temperature immediately after the use of the equipment.

# Important Safety Information-3

## Remark

**Do not drink water that has been inside the unit for an extended period of time. Do not drink the first use of hot water from the unit in the morning.**

**Clean the filter on the water inlet as frequently as required by the quality of your local water.**

**Keep the area around the unit clean.**

If boxes, weeds, cobwebs, cockroaches etc. are in the vicinity of the unit, damage or fire can result.

**Do not install the equipment where the exhaust will blow on walls or windows.**

**Treat hard, acidic or otherwise impure supply water with approved methods to ensure full warranty coverage.**

**Problems resulting from scale formation are not covered by the warranty.**

**Check ignition during use and extinction after use.**

**This unit is only approved for installation up to 1300m. above sea level.**

**Do not discharge cold water from the hot water tap when the power on/off button is off.**

When discharging hot water, check to make sure the ON/OFF is on.

When discharging cold water from the hot water supply tap while the ON/OFF Button is off, condensation will occur within the heat exchanger causing poor combustion and damage to electrical components may occur as a result.

In the case of single-lever water tap, discharge cold water by completely turning the lever to the cold water side.

**Do not use parts other than those specified for this equipment.**

**If the mains electricity and gas are to be turned off for any long periods during severe weather, it is recommended that the whole system, including the boiler, should be drained to avoid the risk of freezing.**

**If it is snowing, check the exhaust gas vent and exhaust vent terminal for blockage.**

**Do not disassemble the remote controller.**

**Do not use benzene, oil or fat detergents to clean the remote controller.**

This may cause deformation.

**Do not splash water on the remote controller. Do not expose the remote controller to steam.**

Do not locate the remote controller near stoves or ovens, this may cause damage or failure.

**Do not get the remote controller wet.**

Although it is water resistant, too much water can cause damage.

**Preventing damage from freezing (p.34 -36)**

Damage can occur from frozen water within the device and pipes even in warm environments.

Be sure to read below for appropriate measures.

Repairs for damage caused by freezing are not covered by the warranty.

**If you do not use the product for long time, contact your nearest agency of ANDREWS WATER HEATERS. (p.35)**

In order to prevent the freeze and bare possibility of gas leakage.

**Clean up the bathtub and the wash stand frequently.**

If the boiling scale remains, slight copper ion contained in water reacts with fatty acid contained in soap etc. and it may get discolored to blue.

**Do not use water from hot springs, wells and ground water.**

A foreign object may attach to the piping in the equipment or the piping may become eroded and may cause water leakage depending on the water quality.

The repair in this case will be implemented with charge even within the guarantee period.

**Condensate Drainage Blockage.**

As safety feature, the water heater will stop working if the condensate drainage becomes blocked. During freezing conditions period this may be due to the forming of ice in the condensate drainage at the external part which locates out of the house.

Remove ice blockage by using of warm cloths around the pipe, and press the Power On/Off Button to turn off, then turn on again to reset. Then the water heater should resume operation. Contact ANDREWS WATER HEATERS, if the fault persists.



# Overview of Condensing Gas Water Heater

This water heater is a high efficiency, fully condensing appliance. Unlike a traditional water heater, a condensing type captures heat from the exhaust gas and uses it to preheat the incoming cold water as it passes through the secondary heat exchanger as illustrated below.

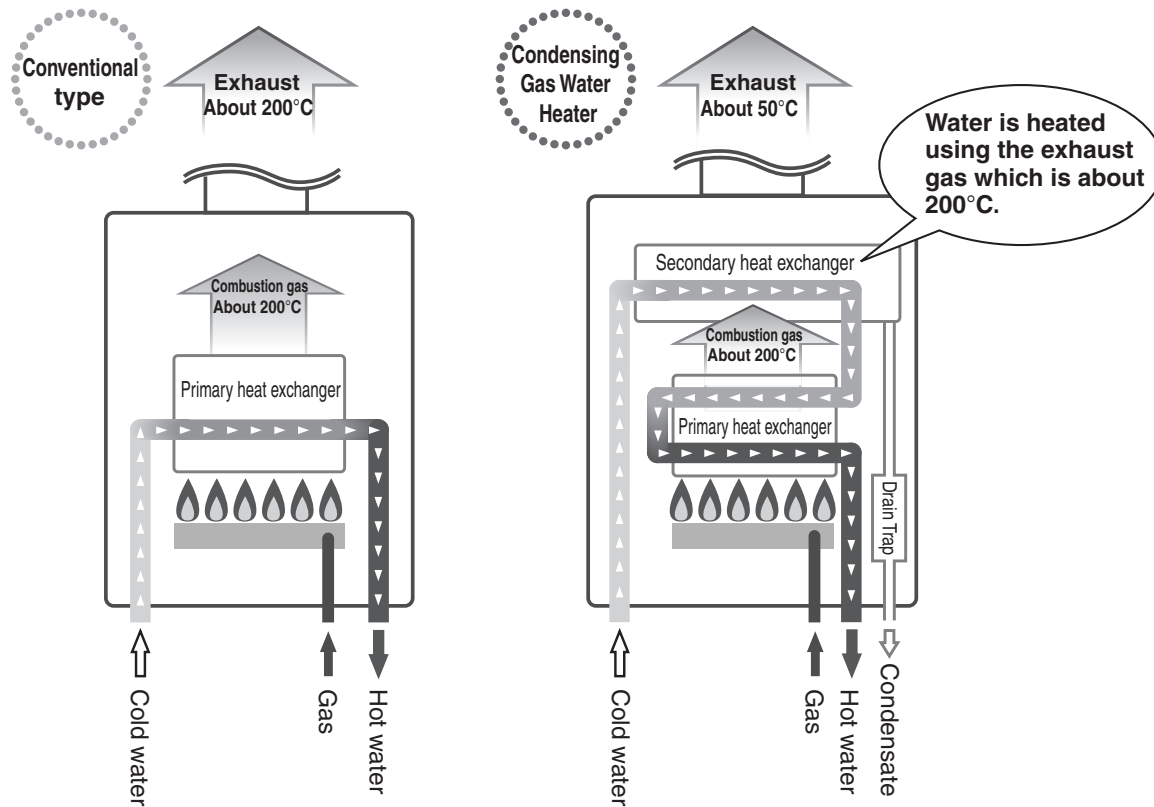

## The condensing gas water heater discharges condensate.

When heat from the exhaust gas is collected within the secondary heat exchanger, condensation occurs from moisture in the exhaust gas and the resulting water is discharged from the drain pipe (approx. 100cc/min maximum). It is not a water leak. Do not plug or block the drain line as it must always be allowed to freely flow.

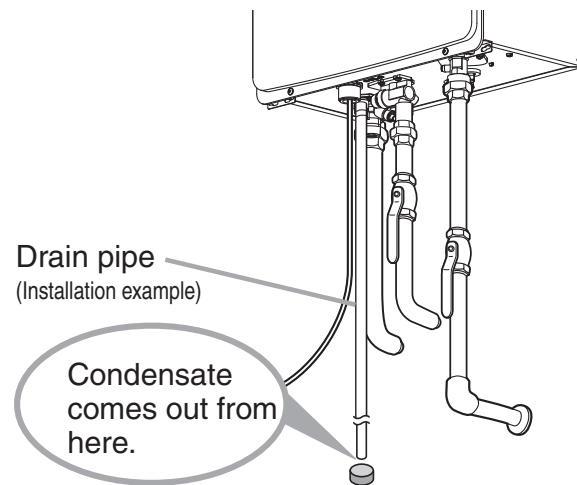

## The condensing gas water heater tends to show white steam.

After the exhaust gas passes through the secondary heat exchanger, it becomes low in temperature and moisture rich which tends to produce steam at the vent discharge terminal. This is a normal occurrence.

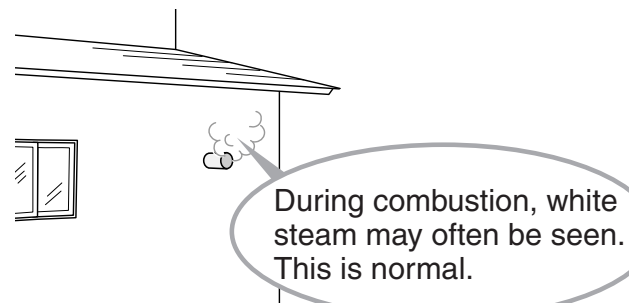

# RC-9018C <Optional> Operation Overview

## Basic operation

It is possible to automatically turn the water heater "ON" or "OFF".

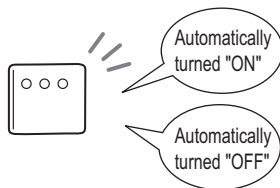

p.20

It is possible to lock remote controller operation.

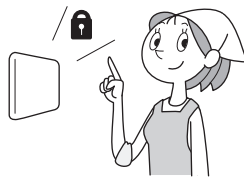

p.22

[For recirculation systems (System [ Rcirc ])] It is possible to circulate hot water only during preferred times of day.

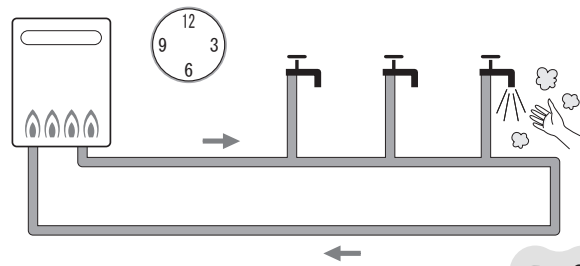

p.28

[When using only one water heater:] It is possible to set the remote controller to alert the user when the water delivery volume has reached a preset fill volume.

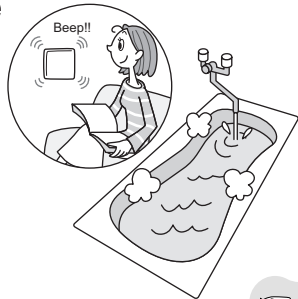

p.32

### Power Saving Mode

The initial setting is set to "Powersave dsply : No-1"

If you set "Powersave dsply" to "Yes" (p.24), unnecessary power consumption by the remote controller is prevented. If approximately ten minutes pass without using hot water or without pressing a button, the display of the remote controller turns off.

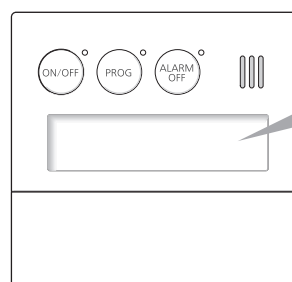

The display turns off (operation is "ON")

- \* If you use hot water or press a button, "Powersave dsply" is released.
- If you press the PROG button only once, "Powersave dsply" is released and the automatic program function will operate.
- \* If the setting temperature is set to 55°C or more, "Powersave dsply" will not function to prevent accidental scalding.
- \* If "Recirc" is operating, "Powersave dsply" will not function.

This setting is adjustable p.24

## User Preferences

The remote controller can be customized based on the preference of the user in the following ways:

The set temperature can be restricted to a maximum level to prevent high temperature settings from being selected.

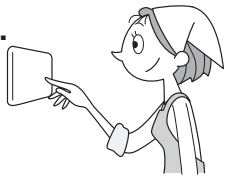

Adjusting the Maximum Output Temperature  p.24

The clock display can be shown even though the power ON/OFF button is set to "OFF".

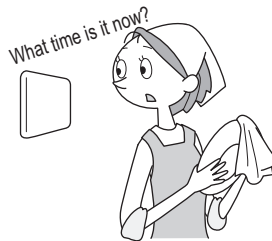

The remote controller display can be turned off to save power.

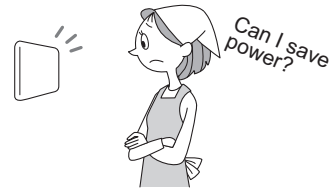

Power Saving Modes  p.24

The brightness of the remote controller can be adjusted for better visibility.



Remote Controller Display Brightness Settings  p.25

The remote controller can be muted so that it does not emit a tone when a button is pressed.

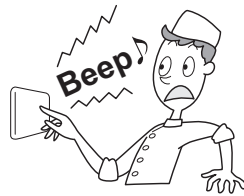

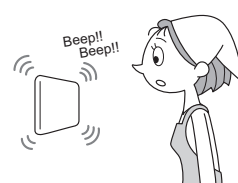

Muting the Remote Controller  p.25

The remote controller can be muted so that it does not emit a tone when an error occurs.



Error Tone Settings  p.25

### >> Additional Settings

- ▶ Draining the water heater (freeze prevention).  p.26 "Draining the Water Heater"
- ▶ Restoring default remote controller settings.  p.26 "Restoring Default Settings"

# General Parts-1

## Main Unit

[WHiX49, LWHiX49, WHiXC56, LWHiXC56]  
Outdoor Wall Mounted, Power flue Model

Flue Collar

Front Cover

Burner on indicator

If there is a problem with the unit,  
a lamp will flash on the front of  
the unit. (☞ p.44)

Air Inlet

Inlet water filter

(Inside Water Inlet) (☞ p.39)

Water Supply Valve

Gas Supply Valve

External Weatherproof Power Point

Drain Pipe - Condensing Model only

Discharges the condensate

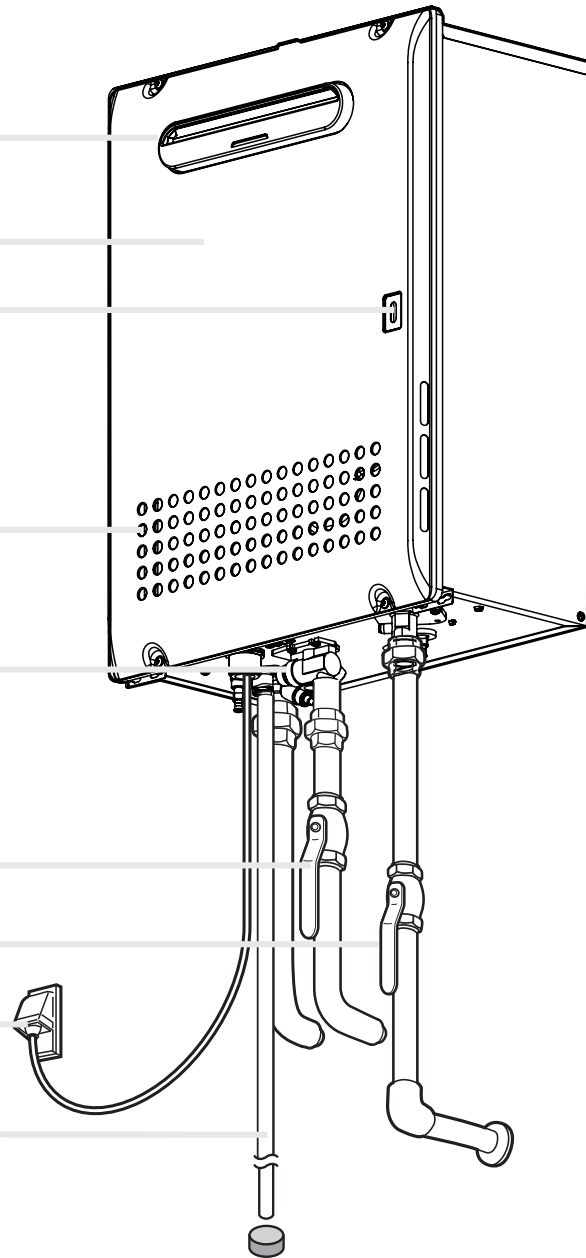

Ex. WHiXC56, LWHiXC56

\* The above illustration shows an example of installation.  
The exact installation configuration may be slightly different.

## Main Unit

[WHiC56, LWHiC56]  
Indoor Wall Mounted, Power Vent/Sealed Model

Intake Pipe

Exhaust Pipe

Front Cover

Burner on indicator

If there is a problem with the unit,  
a lamp will flash on the front of  
the unit. (☞ p.44)

Water Drain Valve  
(with Water Filter)

(Inside Water Inlet) (☞ p.39)

Water Supply Valve

Gas Supply Valve

External Weatherproof Power Point

Drain Pipe

Discharges the  
condensate.

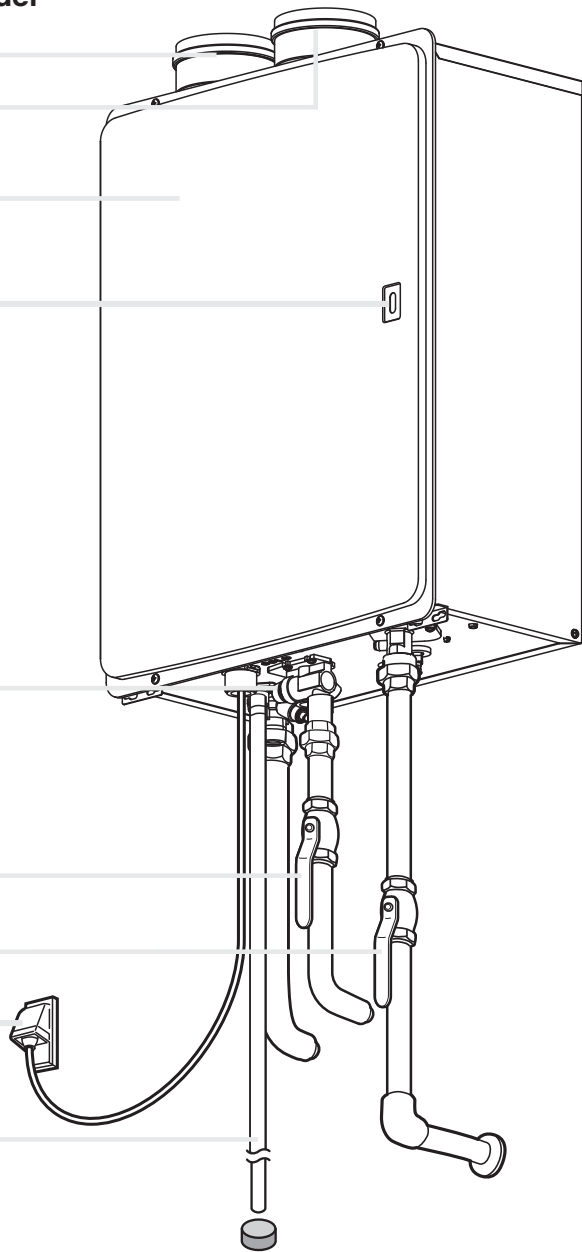

**\* The above illustration shows an example of installation.**

The exact installation configuration may be slightly different.

# General Parts-2

## Main Unit

[WHi49, LWHi49]  
Indoor Wall Mounted, Power Vent/Sealed Model

Coaxial Pipe

Front Cover

Burner on indicator

If there is a problem with the unit,  
a lamp will flash on the front of  
the unit. (☞ p.44)

Water Drain Valve  
(with Water Filter)  
(Inside Water Inlet) (☞ p.39)

Gas Supply Valve

Water Supply Valve

External Weatherproof Power Point

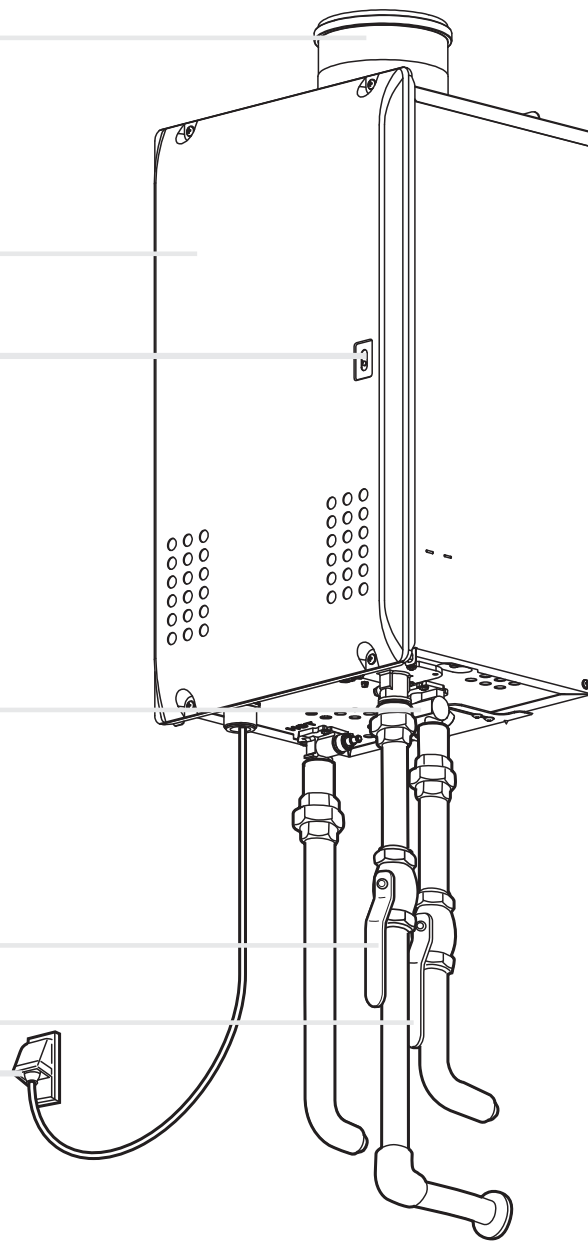

\* The above illustration shows an example of installation.  
The exact installation configuration may be slightly different.

# Names and Functions of Controllers-1

## Main Controller (RC-9018C) <Optional>

The remote controller will emit a tone when a button is pressed.

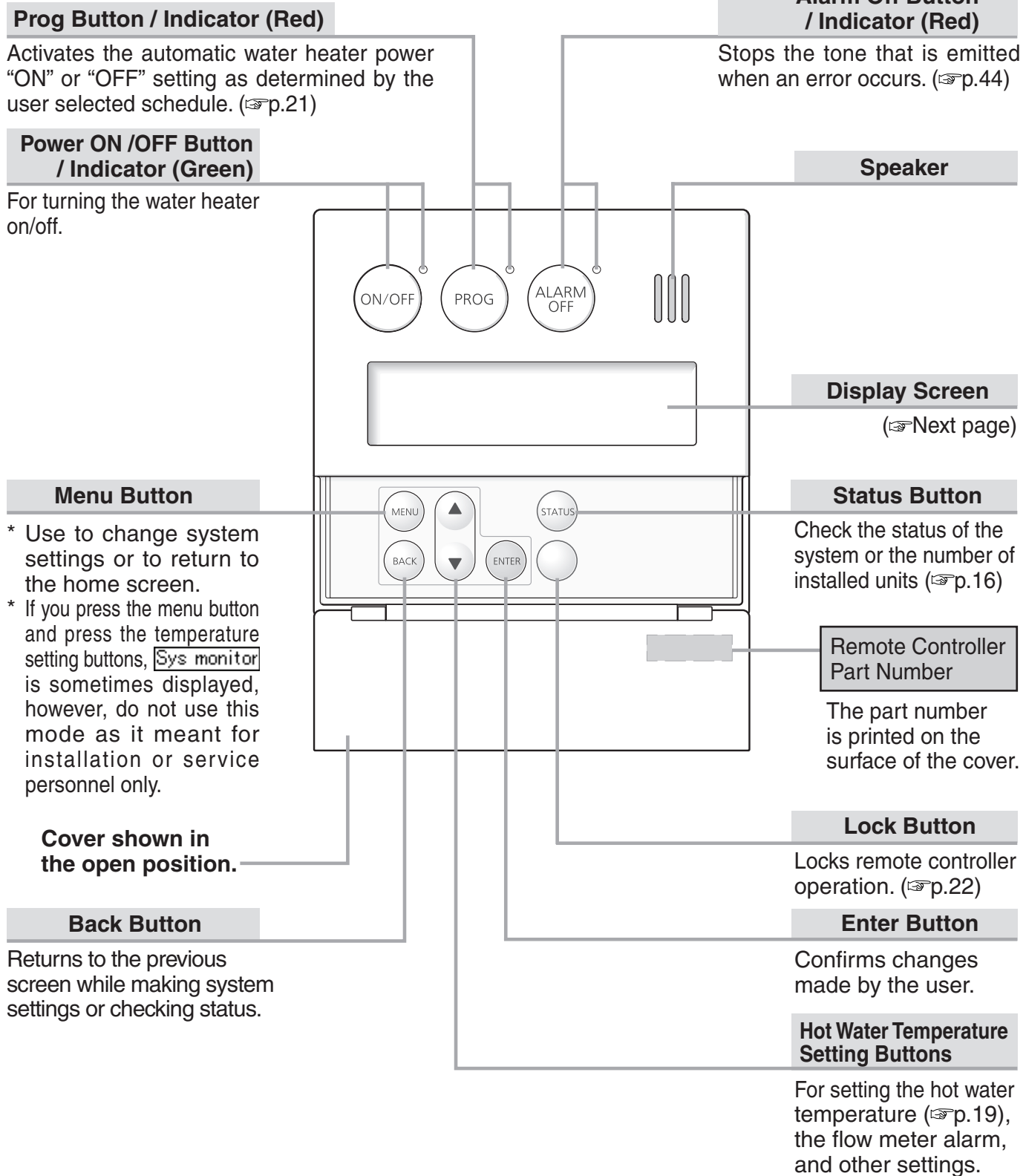

# Names and Functions of Controllers-2

## Screen Display

- \* The screen display shown below is for illustration purposes only. The actual display will vary depending on how the water heater is being used.
- \* After a button is pressed, the display will gradually become darker to prevent unnecessary power consumption by the remote controller.

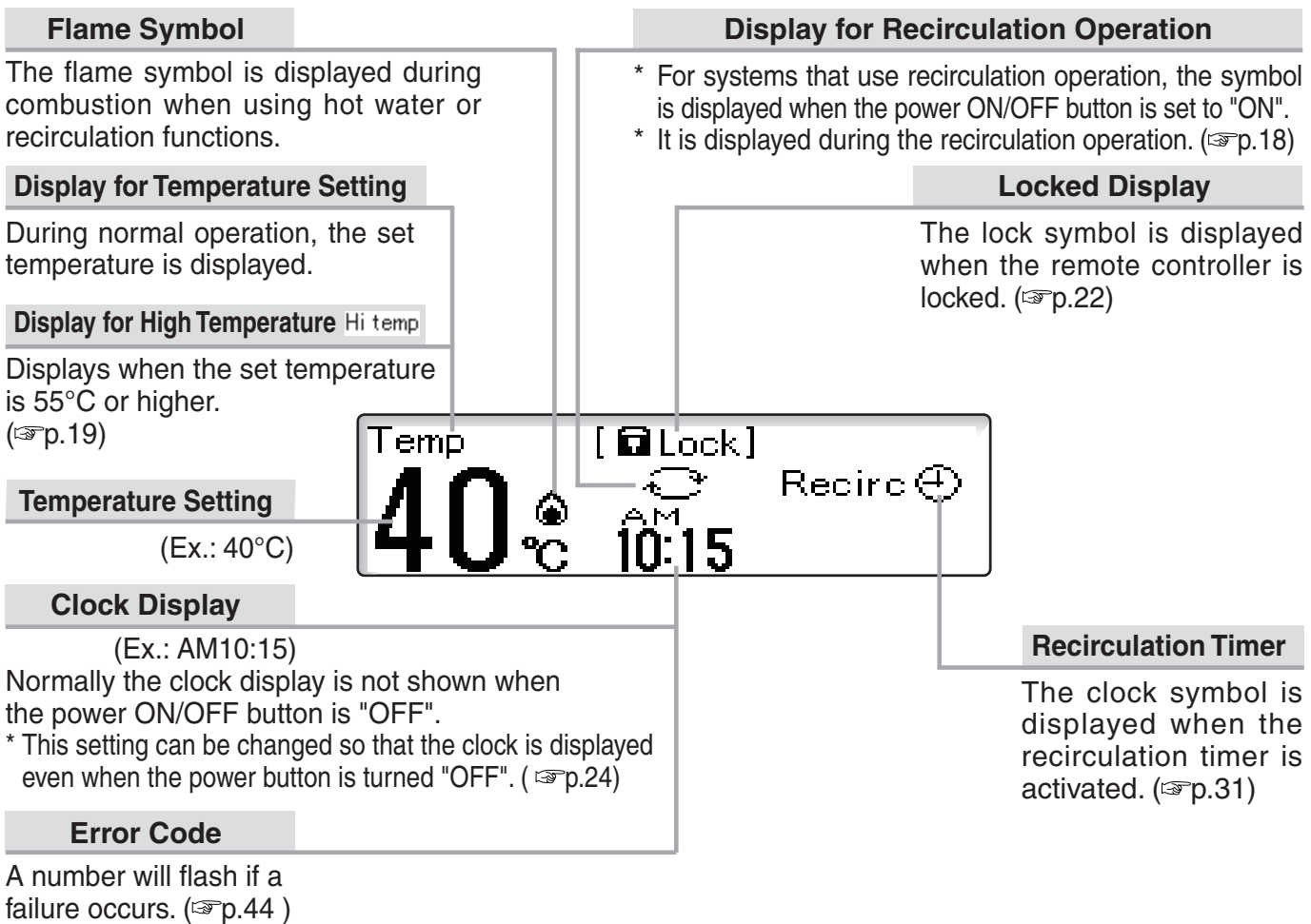

## What is the home screen?

The home screen is displayed when the  button is "ON". Normally, the hot water temperature and the clock, etc. are displayed.

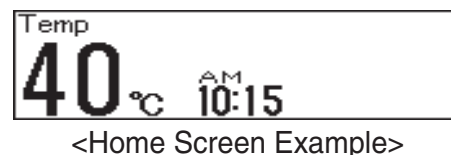



# Initial Operation

Before the first use of your water heater, make the following preparations.

Follow steps **1 through 4**

**1** Open the water supply valve.

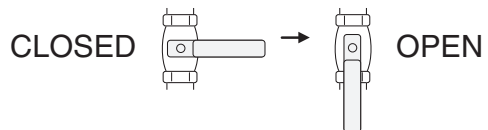

**2** Open a hot water fixture to confirm that water is available, and then close the fixture again.

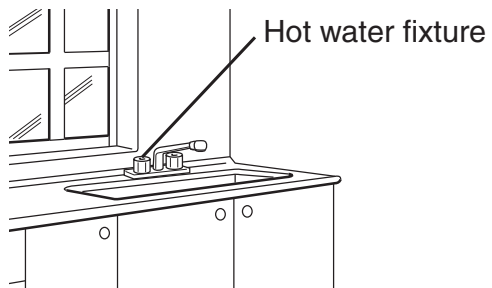

**3** Open the gas supply valve.

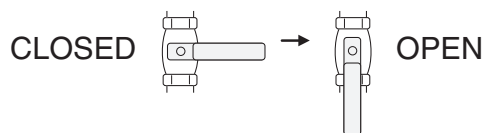

**4** Turn on the power.

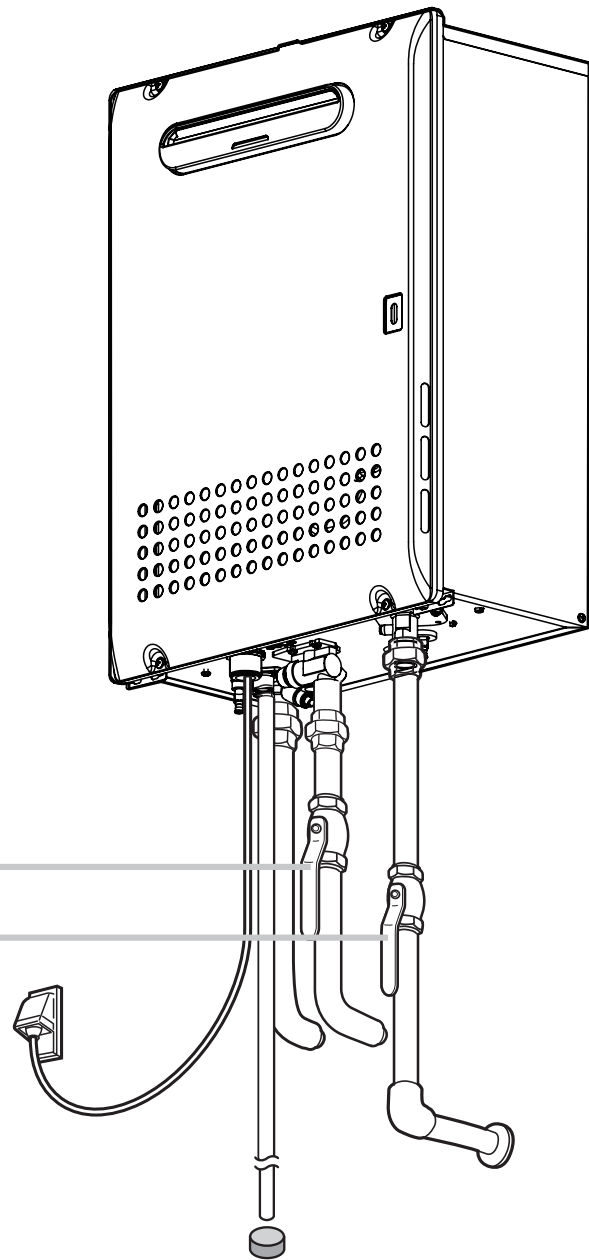

Ex. WHiXC56, LWHiXC56

# System Check



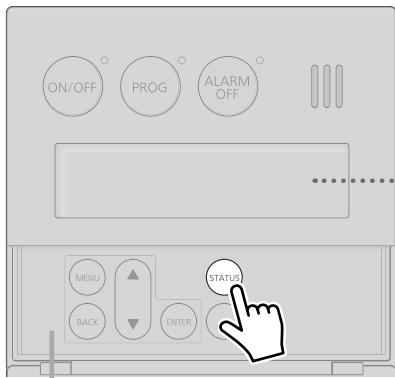

If you press the  button, you can check the status of the system



Cover shown in the open position.

```
System [ Rrcrc ] Active [ 06 ]
Units [ 06 ] Pump1 [ OFF ]
Online [ 06 ] Pump2 [ ON ]
```

(Display Screen Example [System [Rrcrc] ])

System Displayed on the Remote Controller	System Description
System [ Std ]	Water heater only operation.
System [ Rrcrc ]	<ul style="list-style-type: none"> <li>* Water heater and recirculation operation.</li> <li>* During recirculation operation, hot water is always circulated in the piping to provide instant hot water when a fixture is opened.</li> </ul> [If you set the  button to "ON",  is displayed. (If "synchro ON/OFF" is set to "ON". (  p.28))]
System [ Tank ]	<ul style="list-style-type: none"> <li>* Water heater combined with a storage tank operation.</li> <li>* If a recirculation system is also installed, hot water is always circulated in the piping to provide instant hot water when a fixture is opened.</li> </ul> [If you set the  button to "ON",  is displayed.]





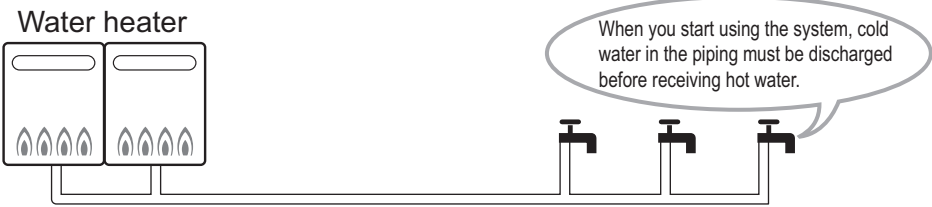
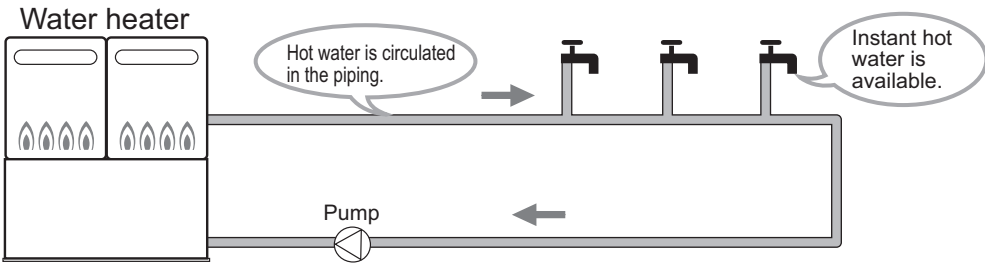
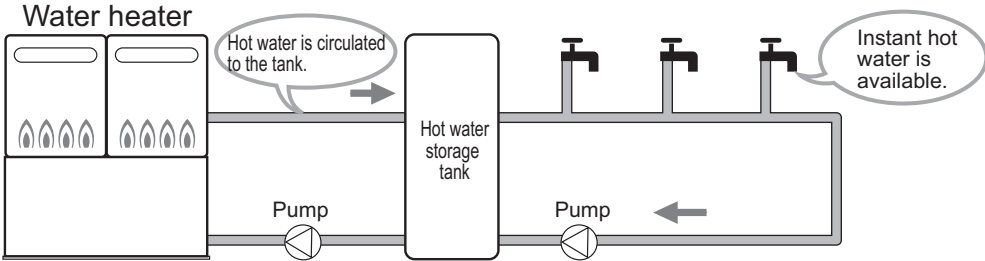

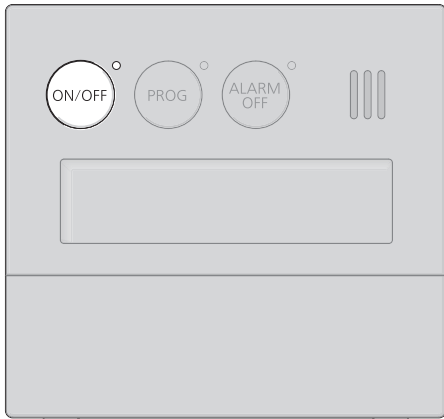

Depending on the configuration of your system, not all functions may be used.

<b>General System Diagram</b> * The number of water heaters, fixtures, and pumps will vary depending on the configuration of the hot water system.	<b>Applicable Remote Controller Functions</b>
	<b>Functions other than those shown on pages 28 to 31 can be used.</b>
	<b>All functions can be used.</b>
	<b>Functions other than those shown on pages 28 to 33 can be used.</b>

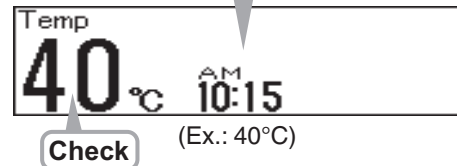

# Using the Water Heater [For All Systems]

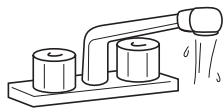

\* If System [ Tank ] is displayed, hot water will be discharged at the temperature of the storage tank.

Operation	Screen Display	Description
<b>1</b>  button is "ON".	For systems with recirculation operation,  is displayed here. 	* The  indicator is lit. * The previously set hot water supply temperature is shown. [For systems with recirculation operation] * If you set the  button to "ON", recirculation operation is automatically started. (If "Synchro ON/OFF" was set to "ON". (p.28)) * The setting temperature displayed may vary from the actual temperature at the fixture depending on conditions such as season or length of piping.
<b>2</b> Turn on hot water. 		

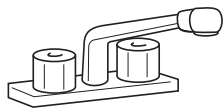
## ● Turn off the hot water

Turn off hot water. 		* During operation, the symbol  may be continuously lit.
---	--	---

**DANGER**

 To prevent scalding:  
High Temperature

Hot Water Heater temperatures over 50°C can cause severe burns instantly or death from scalding.

- Children, disabled and elderly are at the highest risk of being scalded. Feel water temperature before bathing or showering. Temperature limiting valves are available, ask licensed installer.
- When setting the unit to 55°C or higher, "Hi temp" will flash for 10 seconds and emit a tone as a high temperature warning.
- Take caution when using the unit again after setting to 50°C or higher. Always check the set temperature before use.

  
Remote Controller Display  
Flashing for 10 sec





# Setting Hot Water Temperature [For All Systems]

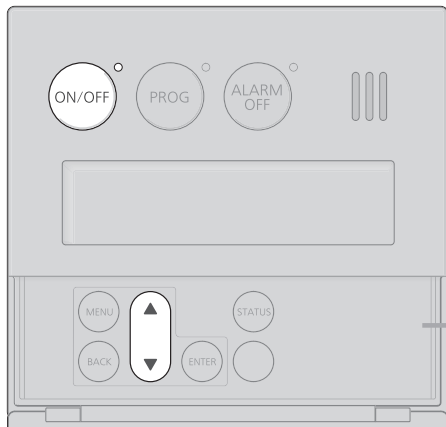

\* If System [ Tank ] is displayed, hot water will be discharged at the temperature of the storage tank.

Cover shown in the open position.

Operation	Screen Display	Description
<b>1</b> ON/OFF button is "ON".		* The ON/OFF indicator is lit. * The previously set hot water supply temperature is shown.
<b>2</b> Set the temperature using the  buttons inside the cover.		

## Temperature Setting Options

■ When using °C mode: (°C: The temperature settings below are examples. The temperature setting necessary depends on the usage, the length of piping and the time of year.)

37	38	39	40	41	42	43	44	45	46	47	48	50	55	60	65	70	75	80	85		
Washing dishes, etc.												Shower, hot water supply, etc.								High temperature	

\*Initial factory setting is 40°C

< Display when high temp is set >

Blinks for approximately 10 seconds → Lit.

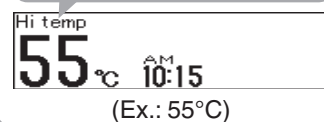

If fixtures incorporate mixing valves, set the temperature higher than usual.

- \* For applications that occasionally require a higher temperature setting, locate the remote controller in a convenient location.
- \* Consult local codes for minimum operating temperatures.

- Hot water temperatures shown are approximate and may differ from the actual temperature at the fixture depending on external factors such as the season and length of piping in the system.
- When low temperatures are set (for washing dishes, etc.), if the incoming water temperature is already quite high, it may be difficult to ensure the outgoing water temperature is as per the setting.
- Please check the temperature displayed before using any hot water. Be especially careful using hot water after the set temperature has been changed.
- When the hot water temperature is adjusted using thermostat controlled water mixing valves, set the temperature on the remote controller approximately 10°C higher than the required temperature to ensure the appropriate fixture temperature.

# Automatic Water Heater "ON" or "OFF" Operation

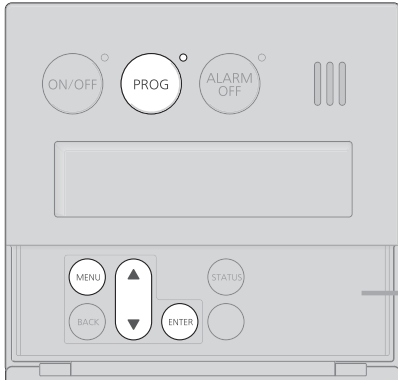

Cover shown in the open position.



- \* If you set the time to turn "ON" or "OFF" the button, the button is automatically turned "ON" or "OFF" at the set time every day by just turning the button "ON".
- \* It is also possible to set only "ON" or "OFF" operation.
- \* For recirculation systems, circulation is started or stopped according to the button condition, "ON" or "OFF".

## Set the time to turn "ON" or "OFF" the button automatically

Operation	Screen Display	Description
This example describes setting the "ON time" and "OFF time" to 10:00 am and 8:00 pm, respectively.		
<b>Preparation</b> <ol style="list-style-type: none"> <li>1. Check that the current time is properly set. (Setting the time  p.21)</li> <li>2. Check the  button is set to "OFF"</li> </ol>		
<b>1</b> <ol style="list-style-type: none"> <li>1) Press the  button inside the cover, Select "Set PROG" using the  buttons.</li> <li>2) Press the  button.</li> </ol>	<ol style="list-style-type: none"> <li>1) </li> <li>2) </li> </ol>	<ul style="list-style-type: none"> <li>* You can set the time regardless if the  button is "ON" or "OFF".</li> <li>* The previously set "Start time" and "End time" are displayed.</li> </ul>
<b>2</b> <ol style="list-style-type: none"> <li>1) Set the ON time to "AM10:00" using the  buttons.</li> <li>2) Press the  button to complete the setting.</li> </ol>	<ol style="list-style-type: none"> <li>1) </li> <li>2) </li> </ol>	<ul style="list-style-type: none"> <li>* The time changes in 10-minute increments with each press of the button, and then in 1-hour increments if the button is kept pressed down.</li> <li>* If the previous setting is OK, press the  button without setting "Start time".</li> <li>* If you do not want to set the "Start time", select "-:--" (located between AM 11:50 and PM 0:00 settings).</li> </ul>
<b>3</b> <ol style="list-style-type: none"> <li>1) Set the OFF time to "PM8:00" using the  buttons.</li> <li>2) Press the  button to complete the setting.</li> </ol>	<ol style="list-style-type: none"> <li>1) </li> <li>2) </li> </ol>	<ul style="list-style-type: none"> <li>* The time changes in 10-minute increments with each press of the button, and then in 1-hour increments if the button is kept pressed down.</li> <li>* If the previous setting is OK, press the  button without setting "End time".</li> <li>* If you do not want to set the "End time", select "-:--" (located between AM 11:50 and PM 0:00 settings).</li> </ul>

## [For All Systems]

**Hint for operation** Following this procedure allows for automated control of water heater operation without user interaction.  
 \* The setting time shown on the display of the remote controller is for example purposes only.

■ **Ex. 1: Both "ON" and "OFF" functions are automated.**

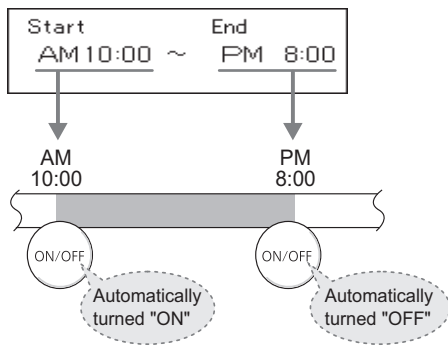

■ **Ex. 2: Only "ON" function is automated.**

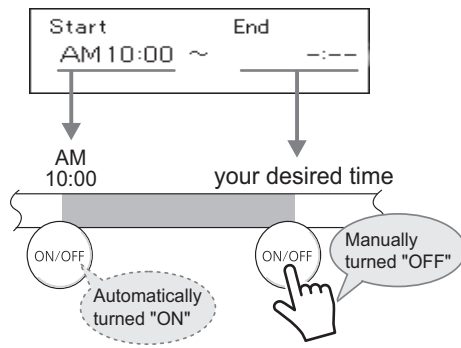

■ **Ex. 3: Only "OFF" function is automated.**

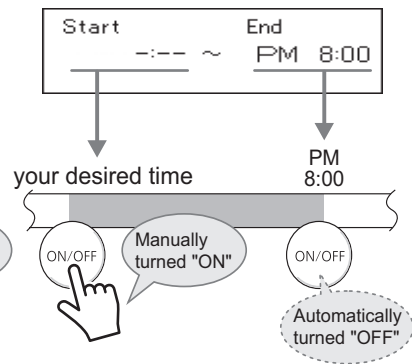

Operation	Screen Display	Description
<p><b>4</b> Check "Set" is selected, and then press  button to confirm all settings.</p>		<ul style="list-style-type: none"> <li>* If you do not press  button, the time setting is not completed.</li> <li>* If you want to change "ON/OFF time", select "Reset" and then press the  button, return to step 2.</li> </ul>

### Activate Automatic Operation

Operation	Screen Display	Description
<p><b>1</b>  button is "ON".</p>	 (Display Example)	<ul style="list-style-type: none"> <li>* You can activate automatic operation regardless if the  button is "ON" or "OFF".</li> <li>*  indicator is lit when activated.</li> <li>* "Start time" and "End time" will be displayed upon activation.</li> <li>* If both the "Start time" and "End time" are set to "- : -", the alarm sounds "Pi Pi Pi" and</li> </ul> is displayed.

### ● To Deactivate Automatic Operation

<p> button is "OFF".</p>	<ul style="list-style-type: none"> <li>* The  indicator is unlit.</li> </ul>
--------------------------	--

- \* If the button is not set to "OFF", the water heater will automatically turn "ON" or "OFF" at the set times.
- \* If there is a power failure or power is disconnected to the water heater, automatic operation will be deactivated.



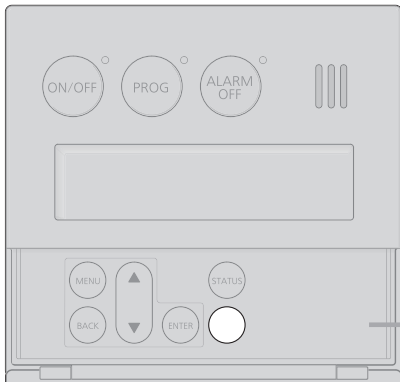





# Locking the Remote Controller [For All Systems]



Cover shown in the open position.

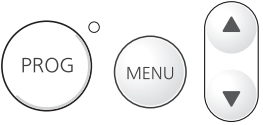

By locking the remote controller, the settings cannot be accidentally changed if a button is pressed by mistake.

Operation	Screen Display	Description
<p><b>1</b> Press and hold  button for approximately 2 seconds to lock the remote controller.</p>		<ul style="list-style-type: none"> <li>* The operation can be locked regardless if the  button is "ON" or "OFF".</li> <li>* The operations of , , and  buttons are locked.</li> <li>* Approximately 3 seconds after locking the remote controller, the display will return to the previous screen.</li> </ul>
<p><b>If you press these buttons</b></p>  <p>while the remote controller is locked, the "Locked" screen will appear.</p>		<ul style="list-style-type: none"> <li>* Approximately 3 seconds after the "locked" screen appears, the display will return to the previous screen.</li> </ul>

## ● To Unlock the Remote Controller

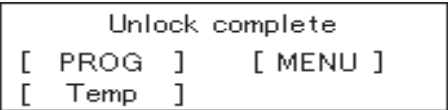
<p>Press and hold  button for approximately 2 seconds to unlock the remote controller.</p>		<ul style="list-style-type: none"> <li>* Approximately 3 seconds after unlocking the remote controller, the display will return to the previous screen.</li> </ul>
---	--	--



# Clock Adjustment [For All Systems]

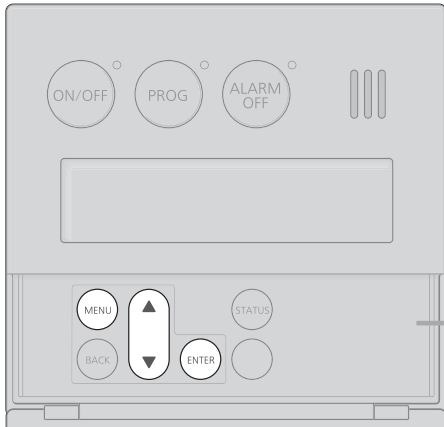

Cover shown in the open position.

Operation	Screen Display	Description
<b>1</b> Press the  button inside the cover.		* This adjustment can be made regardless of whether the  button is ON/OFF.
<b>2</b> Press the  button.		
<b>3</b> <ol style="list-style-type: none"> <li>Use the  buttons to reset the clock.</li> <li>Press the  button to complete the clock setting.</li> </ol>	<ol style="list-style-type: none"> <li> </li> <li> </li> </ol> <p>The screen returns to the previous screen.</p>	* The time changes in 1-minute increments with each press of the button, and then in 10-minute increments if the button is kept pressed down. * If the display is left untouched for approximately 20 seconds without pressing the  button, the setting will be completed. When the  button is turned ON, the home screen will be restored.

\* In the event of a power outage or after disconnecting power to the water heater, when power is restored, the clock on the display screen will show " - : - - " and the clock will need to be reset.

\* Normally, when the button is turned OFF, the clock display disappears, but it is possible to display the clock when the button is turned OFF by changing a setting. (→ p.24)

# Customizable Settings <Misc settings>

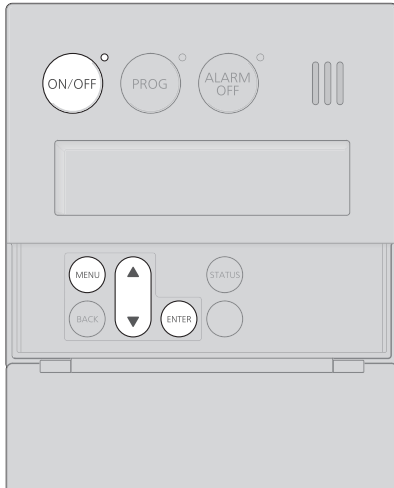

## Adjusting the Maximum Output Temperature.

The maximum output temperature can be limited to prevent discharging hot water at too high of a temperature.

**1** button is "OFF".

**2** Press the button inside the cover, Select **Misc settings** using the buttons.

Press the button.  
The "Misc settings" screen appears.

**3** Select **Max set temp** using the buttons, and then press the button.

**4** Change the setting using the buttons.

Max set temp  
↓ [ 85 °C ]

(Ex: 85°C)

37 - 48°C (In 1°C intervals),  
50 - 85°C (In 5°C intervals)

(Initial setting=85°C)

Setting completed

## Display Screen Power Saving Mode [powersave dsply]

To conserve power consumption by the display, it can be turned off completely or set to only display the clock when the power ON/OFF button is turned "OFF".

**1** Press the button inside the cover, Select **Misc settings** using the buttons.

Press the button.  
The "Misc settings" screen appears.

**2** Select **Powersave dsply** using the buttons, and then press the button.

**3** Change the setting using the buttons.

Powersave dsply (Clock hidden)  
⇄ [ No-1 ]

(Ex: No-1)

**Yes:** the display will turn off and the clock will not be displayed when the power ON/OFF button is turned "OFF".

**No-1:** the display will not turn off and the clock will not be displayed when the power ON/OFF button is turned "OFF".

**No-2:** the display will not turn off and the clock is displayed when the power ON/OFF button is turned "OFF".

(Default setting=No-1)

Setting completed

To change other settings, select the option and press the button.

To return to the home screen, press the button or let it sit for approximately 20 seconds.

## [For All Systems] -1

### Adjusting the brightness of the display screen when the remote controller is turned on.



The display screen can be brightened or darkened or the backlight can be turned off completely.

**1** Press the  button inside the cover, Select **Misc settings**

using the  buttons.

Press the  button.

The "Misc settings" screen appears.

**2** Select **Brightness** using the  buttons, and then press the  button.

**3** Change the setting using the  buttons.

Brightness  
↔ [ Normal ]

(Ex: Normal)

Dark / Dim / Normal / Bright

(Default setting=Normal)

Setting completed

### Muting the remote controller.



The remote controller can be muted so that it does not emit a tone when a button is pressed.

**1** Press the  button inside the cover, Select **Misc settings**

using the  buttons.

Press the  button.

The "Misc settings" screen appears.

**2** Select **Touch sound** using the  buttons, and then press the  button.

**3** Change the setting using the  buttons.

Touch sound  
↓ [ Yes ]

(Ex: Yes)

Yes / No

(Default setting=Yes)

Setting completed

### <System dependent option>

#### Error Tone Settings.



The remote controller can be muted so that it does not emit a tone when an error occurs.

**1** Press the  button inside the cover, Select **Misc settings**

using the  buttons.

Press the  button.

The "Misc settings" screen appears.

**2** Select **Error alarm** using the  buttons, and then press the  button.

**3** Change the setting using the  buttons.

Error alarm  
↓ [ Yes ]

(Ex: Yes)

Yes / No

(Default setting=Yes)

Setting completed

To change other settings, select the option and press the  button.

To return to the home screen, press the  button or let it sit for approximately 20 seconds.

# Customizable Settings <Misc settings> -2

[For All Systems]

## Draining the Water Heater.

(☞ Refer to page 33 for details.)

**1** ON/OFF button is "OFF".

**2** Press the MENU button inside the cover, Select Misc settings using the ▲/▼ buttons.

Press the ENTER button.  
The "Misc settings" screen appears.

**3** Select Drain water using the ▲/▼ buttons, and then press the ENTER button.

**4** Select "YES" using the ▲/▼ buttons.



Press the ENTER button.

Follow the drain procedures in the manual

Drain the water heater following the procedures described on page 35.

### To stop draining water from the water heater

If you press the ENTER button again when "Drain water" and "Operating" are alternately displayed following steps 2 to 3, the drain function will stop.

## Restoring Default Settings.

Select settings can be restored to the factory default conditions. See items marked with a ★ in the "Default Settings" section (☞ p.53).

**1** ON/OFF button is "OFF".

**2** Press the MENU button inside the cover, Select Misc settings using the ▲/▼ buttons.

Press the ENTER button.  
The "Misc settings" screen appears.

**3** Select Default all settings using the ▲/▼ buttons, and then press the ENTER button.

**4** Select "YES" using the ▲/▼ buttons.

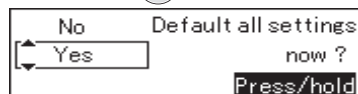

Press and hold the ENTER button for approximately 5 seconds.

Reset complete

Setting completed

To change other settings, select the option and press the ENTER button.

To return to the home screen, press the MENU button or let it sit for approximately 20 seconds.

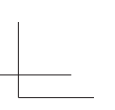
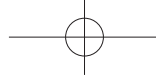
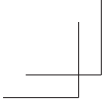

# Notes

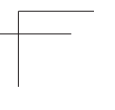
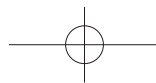
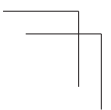

# Enabling Automatic Recirculation Operation

[For System[Rrcrc]]

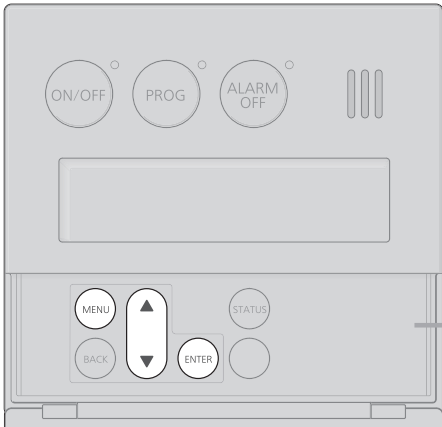

- \* To check system status. (→ p.16)
- \* When “synchro ON/OFF” is set to “Yes”, recirculation can be activated automatically.
- \* To change “synchro ON/OFF” from “Yes” to “No”, follow the same procedure as described below.

Cover shown in the open position.

Operation	Screen Display	Description
<p><b>1</b> 1) Press the  button inside the cover, Select "Recirc menu" using the  buttons.</p> <p>2) Press the  button.</p>	<p>1) </p> <p>2) </p>	<p>* This adjustment can be made regardless of whether the  button is ON/OFF.</p>
<p><b>2</b> Select "Synchro ON/OFF" and press the  button.</p>		
<p><b>3</b> 1) Press .</p> <p>2) Press the  button.</p>	<p>1) </p> <p>2) </p> <p style="text-align: center;">▼</p> <p>The screen returns to the previous screen.</p>	<p>* If the display is left untouched for approximately 20 seconds without pressing the  button, the setting will be completed, and when the  button is turned ON, the home screen will be restored.</p>

# Manually Starting Recirculation Operation



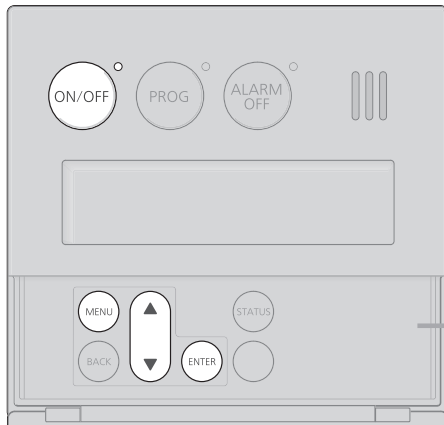





[For System[Rcrc]]

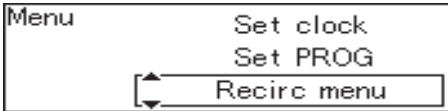
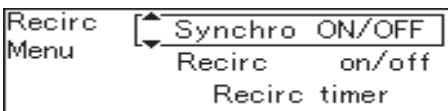

Cover shown in the open position.

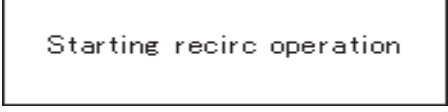

Recirculation operation can be manually stopped or started using this procedure.

Operation	Screen Display	Description
<p><b>1</b></p> <p>1) Press the  button inside the cover, Select "Recirc menu" using the  buttons.</p> <p>2) Press the  button.</p>	<p>1) </p> <p>2) </p>	<p>* You can set this function if the  button is "ON".</p>
<p><b>2</b></p> <p>1) Select "Recirc on/off" using the  buttons.</p> <p>2) Press the  button.</p>	<p>1) </p> <p>2)                       [Display when recirculation is set to "ON"]</p> <p style="text-align: center;">▼</p> <p>The screen returns to the previous screen.</p>	<p>* If the display is left untouched for approximately 20 seconds without pressing the  button, the setting will be completed.</p> <p>[Display when the recirculation is set to "OFF"]</p> <div style="border: 1px solid black; padding: 5px; width: fit-content; margin: 0 auto;">Stopping recirc operation</div>

# Setting the Recirculation System Operation Timer

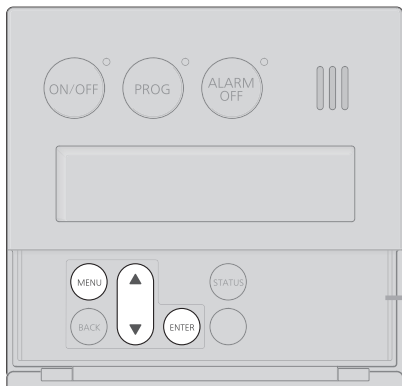

Cover shown in the open position.













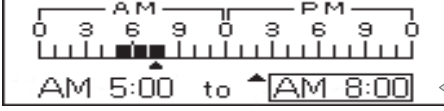



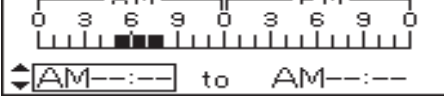

- \* With the recirculation operation timer set, hot water will be automatically circulated in the hot water pipes. Even with this function activated, it may take several minutes for hot water to be completely circulated through the plumbing system. Set the timer to activate the recirculation system prior to the first use of hot water to ensure hot water is instantly available.
- \* Multiple recirculation time periods can be set.
- \* Until the timer is deactivated (p.31), the recirculation system will operate daily at the set times.
- \* When the recirculation system is turned "OFF" by the timer, the water heater will still remain "ON" and can be used normally.



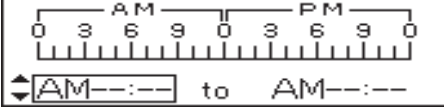

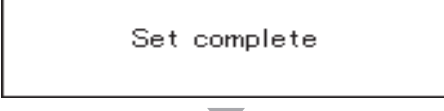
Operation	Screen Display	Description
This example describes setting the recirculation system to operate between 5:00 am - 8:00 am.		
<b>Preparation</b> Check that the current time is properly set. (Setting the time p.17)		
<p><b>1</b> 1) Press the <b>MENU</b> button inside the cover, Select "Recirc menu" using the <b>▲</b> buttons.</p> <p>2) Press the <b>ENTER</b> button.</p>	<p>1) Menu Set clock Set PROG Recirc menu</p> <p>2) Recirc Menu Synchro ON/OFF Recirc on/off Recirc timer</p>	* You can set the timer regardless if the <b>ON/OFF</b> button is "ON" or "OFF".
<p><b>2</b> 1) Select "Recirc timer" using the <b>▲</b> buttons.</p> <p>2) Press the <b>ENTER</b> button.</p>	<p>1) Recirc Menu Synchro ON/OFF Recirc on/off Recirc timer</p> <p>(Example of a display)</p> <p>2) 0 3 6 9 0 3 6 9 0 AM PM AM--:-- to AM--:--</p>	* The previous setting is displayed.
<p><b>3</b> 1) Select "AM5:00" using the <b>▲</b> buttons.</p> <p>2) Press the <b>ENTER</b> button to complete the "Start" time setting.</p>	<p>1) 0 3 6 9 0 3 6 9 0 AM PM AM 5:00 to AM 6:00</p> <p>2) 0 3 6 9 0 3 6 9 0 AM PM AM 5:00 to AM 6:00</p>	<p>* Every time when you press the button, the time changes by one hour.</p> <p>[To keep the current "Start" time] Press the <b>ENTER</b> button without changing the "Start" time, and proceed to step 4.</p> <p>[To add additional time periods to the current setting, or to cancel the previous setting]</p> <p>1) Press the <b>ENTER</b> button without setting "Start" time.</p> <p>2) Press the <b>ENTER</b> button without setting "End" time.</p> <p>3) Follow the procedures "Adding Additional Time Periods" or "Resetting All Time Periods" (p.31).</p>



[For System[Rcrc]]

Operation	Screen Display	Description
<p><b>4</b></p> <p>1) Select "AM8:00" using the  buttons.</p> <p>2) Press the  button to complete the "End" time setting.</p>	<p>1)  <b>Here</b></p> <p>2) </p>	<p>* Every time when you press the button, the time changes by one hour. [To keep the current "End" time]</p> <p>Press the  button without changing the "End" time, and proceed to step 5.</p>
-----		
<Adding Additional Time Periods>		
<p>1) Select "Add" using the  buttons.</p> <p>2) Press the  button.</p> <p>3) Select the time period following the procedures in Steps 3 to 4.</p>	<p>1) </p> <p>2) </p>	<p>* You can set multiple operation time periods.</p>
-----		
<Resetting All Time Periods>		
<p>1) Select "Reset" using the  buttons.</p> <p>2) Press the  button. (All settings are cleared.)</p> <p>3) Adjust the time period following the procedures in Steps 3 to 4.</p>	<p>1) </p> <p>2) </p>	
<p><b>5</b></p> <p>Press the  button to complete the time settings.</p>	<p></p> <p style="text-align: center;">▼</p> <p style="text-align: center;">"Recirc timer" and "Recirc timer on" are alternately displayed on the menu (approximately 10 seconds)</p> <p style="text-align: center;">▼</p> <p></p> <p style="text-align: center;">(Example of home screen when the power ON/OFF button is turned "ON")</p>	<p>* The timer will not activate without pressing the  button.</p> <p>* If the time is not set, the time setting screen is displayed (p.19).</p> <p>* Until the timer is deactivated, the recirculation system will operate daily at the set "Start" and "End" times.</p>

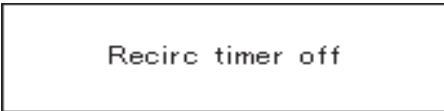
●To Cancel the Recirculation System Operation Timer





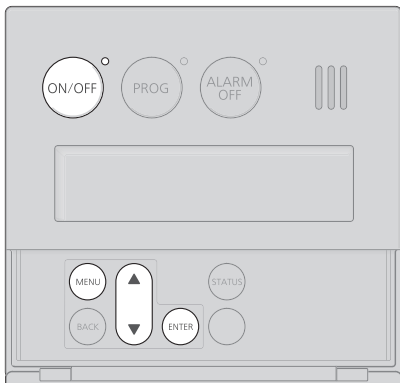





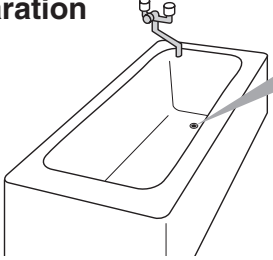

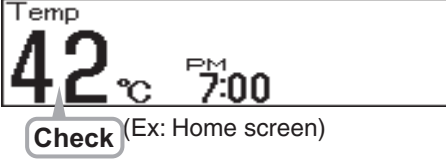
<p>1) Carry out steps 1 to 2.</p> <p>2) Select "Cancelled" using the  buttons.</p> <p>3) Press the  button.</p>	<p>1) </p> <p>2) </p> <p style="text-align: center;">▼</p> <p style="text-align: center;">The screen returns to the Recirc Menu.</p>	<p>* If the  button is "ON", the screen returns to the home screen in approximately 10 seconds.</p> <p>* If the timer is deactivated during a recirculation time period, recirculation will continue until it is stopped using the procedure shown on p.29.</p>
---	--	--

# Flow Meter Alarm [Single Water Heater Only]

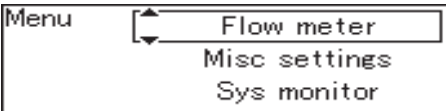

If the flow meter alarm is being used to indicate when water delivery volume is reached to the preset volume.

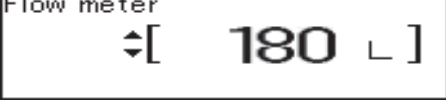
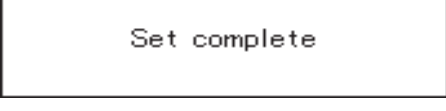
- If any hot water is being used besides what is going into the tub, the alarm will sound before the tub is full.
- If there was water in the tub before the fill began, or if the water is not shut off manually when the alarm sounds, the tub may overflow.
- If there was water in the tub before the fill began, the temperature in the tub after it is full may be different from the temperature setting.

Operation	Screen Display	Description
<b>Preparation</b>  <p>Confirm that the stopper is closed.</p>		
<b>1</b>  button is "ON".	 <p>Temp 42°C PM 7:00 Check (Ex: Home screen)</p>	* The  indicator is lit. * The current setting temperature is displayed.
<b>2</b> 1) Press the  button inside the cover, Select "Flow meter" using the  buttons. 2) Press the  button.	1)  2)  (Ex: Alarm off)	* The current hot water filling volume is displayed.
<b>3</b> Adjust the Flow Meter Alarm volume setting 1) Change the volume with your desired hot water volume.  to 2) Press the  button.	1)  (Ex: 180 L) 2)  Set complete	* The set hot water volume will be stored in memory. * The screen returns to the home screen. * If the display is left untouched for approximately 20 seconds without pressing the  button, the setting will be completed and the home screen will be restored.



## Fill Volume Options

40	60	80	100	120	140	160	180	200	220	240	260	300	340	380	Alarm off
----	----	----	-----	-----	-----	-----	-----	-----	-----	-----	-----	-----	-----	-----	-----------

(L)  
(Default setting = Alarm off)

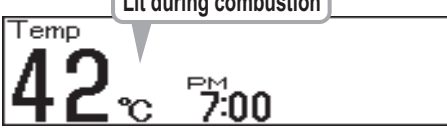
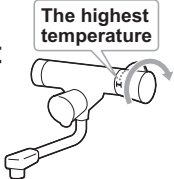
Operation	Screen Display	Description
-----------	----------------	-------------

<p><b>4</b> Turn on hot water.</p> 	<p>Lit during combustion</p>  <p>If the hot water temperature has been set so that it does not require mixing, set the mixing valve to its highest setting.</p> <p>The hot water in the bathtub may become lukewarm if it is mixed with cold water at the fixture.</p> 	
--	--	--

<p><b>5</b> When water delivery volume reached to the preset volume of water, an alarm will sound alerting you to shut off the water.</p>  <p>Turn off the hot water when the alarm sounds to prevent overflowing.</p> 	<p>Please turn off hot water faucet</p>	<ul style="list-style-type: none"> <li>* Why doesn't the flow meter alarm sound even if the water delivery volume reached to the preset volume.</li> <li>* The alarm will continue to sound even if the  button is pressed.</li> </ul>
---	---	---

### Hot Water Filling Temperature Options

(°C : The temperatures settings below are only examples. The temperature setting necessary will depend on the usage, the length of piping and the time of year.)

37	38	39	40	41	42	43	44	45	46	47	48
Warm			Warmer				Hot				

\* Initial factory setting: 40°C

- \* Although the temperature can be set to 50°C or higher, do not set the temperature to 50°C or higher as it can cause severe burns instantly or death from scalding.
- \* The hot water filling temperature is same as the setting temperature.
- \* The setting temperature displayed may vary from the actual temperature at the fixture depending on conditions such as season or length of piping.

# Preventing Damage from Freezing

The heater and piping can be damaged if cold temperatures cause water to freeze inside the unit. The damage can be prevented with the following method:

## Normal cold [outside temperatures between 0°C - 10°C with no wind]

At these temperatures, the units have freeze prevention heaters that will prevent freezing.

- \* **Do not disconnect the power. The freeze prevention heaters will not work if the power is disconnected.**
- \* The freeze prevention will work regardless of whether the operation button on the remote controller has been turned on.

When the temperature drops, the **freeze-prevention heaters** are automatically activated to keep the unit warm and prevent it from freezing.

The freeze prevention heaters will not prevent the plumbing external to the unit from freezing. Protect this plumbing with insulation. If you are still worried that your heater will freeze, contact the nearest ANDREWS WATER HEATERS agent.

## For severely cold temperatures [ outside temperature including wind chill of less than -10°C ]

Run water to prevent freezing.

1. Turn the unit on with the Power Button on the Remote Controller.
2. Close the gas supply valve.
3. Open a hot water fixture and let it run for approx. 2 minute, and then check that the number 11 or F11 is flashing on the remote controller display.
  - \* If multiple units are being used, drain each unit for approx. 2 minute.
  - \* It is possible that a different number may be displayed on the remote controller, but as long as it is flashing, you may continue.
4. Adjust a hot water fixture, and keep a small amount of hot water running. (0.4L/minute or about 4mm thick.)
  - \* If there is a mixing valve, set it to the highest level.
  - \* When linking multiple units, discharge water equivalent to 0.4L/minute per unit.
5. The flow may become unstable from time to time. Check the flow 30 minutes later.

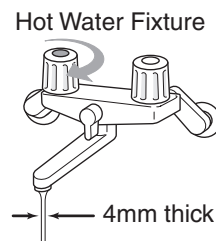

- This method can be applied not only to the heater, but also to the water supply, water piping and mixing valve.
- Remember that if the mixing valve is set to the maximum level, there is a risk of scalding.
- If freezing still might occur, drain the water from the unit following the steps on P21.

## If water will not flow because it is frozen

1. Close the gas and water valves.
2. Turn off the operation button.
3. Open the water supply valve from time to time to check whether water is running.
4. When the water is flowing again, check for water leaks from the equipment and piping, or follow steps 1 through 4 on P11 ("Initial Operation").

- If the heater or the piping is frozen, do not use the heater, or it may become damaged.
- Repairs for damage caused by freezing, is not covered by the warranty.

# When Unused for an Extended Period-1

If the water heater will not be used for a long period of time, drain the water.

## CAUTION



If you do not use the product for long time, contact your nearest agency of ANDREWS WATER HEATERS.

Because the operation in equipment is necessary for complete drainage.

## CAUTION





Whenever the unit is checked, maintained, or drained, the power switch must be turned "Off", and it must be allowed to cool down first.

To prevent scalding.

The water within the appliance is still very hot, for a short period after use.

## Preparation A bucket for draining water.

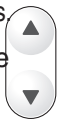
### Drainage Using the Remote Controller

- 1** (1) ON/OFF button is "OFF".
- (2) Press the MENU button inside the cover, Select **Misc settings** using the  buttons. Press the ENTER button. The "Misc settings" screen appears.
- (3) Select **Drain water** using the  buttons, and then press ENTER button.
- (4) Select "YES" using the  buttons,
 

No      Drain water  
 ← Yes      now ?

 Press ENTER button.
 

Follow the drain procedures in the manual

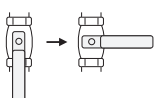
- 2** Close the water supply valve. 

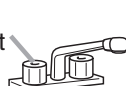
- 3** Fully open all hot water fixtures/faucets. 

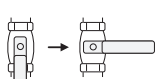

- 4** Open all drain plugs and drain the water out of the unit.

- 5** When the water is completely drained, replace all drain plugs and close the hot water fixtures/faucets.

- 6** Close the gas valve and disconnect the electrical power supplied to the unit. 

**Do not touch with wet hands.**

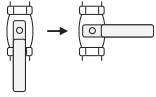
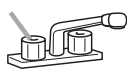
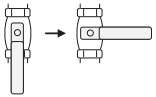
### Manual Draining

- 1** Close the gas valve. 
- 2** (1) Turn the power on/off button "On".  
(2) Turn and leave open the hot water fixtures/faucets for more than 2 minutes and close.   
\* If multiple units are being used, drain two minutes for each unit.  
\* An 11 Error Code may appear on the remote controller. This is not a malfunction of the unit. Do not turn Power ON/OFF Button OFF.
- 3** Close the water supply valve and disconnect the electrical power supplied to the unit.   
**Do not touch with wet hands.**
- 4** Fully open all hot water fixtures/faucets. 
- 5** Open all drain plugs and drain the water out of the unit.
- 6** When the water is completely drained, replace all drain plugs and close the hot water fixtures/faucets.
 

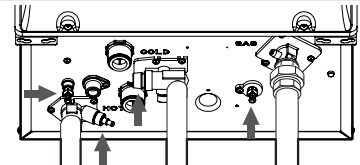

**Drain Plugs** Ex. WHiXC56, LWHiXC56  
Each drain plug might not be visible if insulation is installed around the piping.

## When Unused for an Extended Period-2

If the water heater will not be used for a long period of time, drain the water.

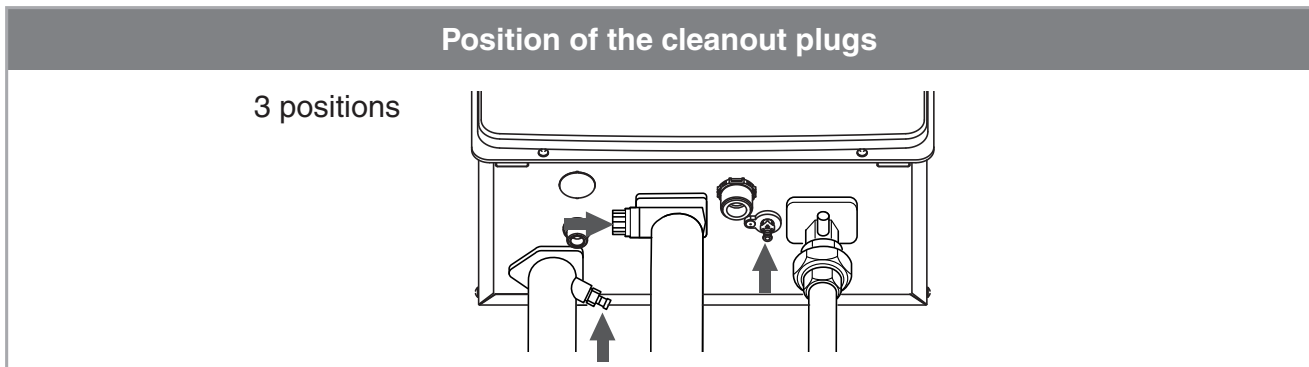

- \* The shapes of the cleanout plugs are as pictured on the right.
- \* The cleanout plugs may not be clearly visible as they are partially hidden behind the pipe insulation.
- \* Water may not drain out fully even though the cleanout plugs are loosened, depending on the pipe arrangement. In this case, fully remove the cleanout plugs. (Make sure not to mislay them.)

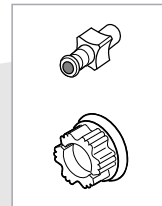

Freezing is prevented within the device automatically by the freeze-prevention heater. Freezing cannot be prevented when the power plug is unplugged Recommendation : the power plug is plugged when heater does not use.

(Only for condensing model)

Water in an internal tank cannot drain to out side if try to drain according to above drain operation. Please contact to service center how to drain water inside of tank to outside.

### Turning the Unit Back On (Condensing model only)

1. Check that all drain plugs are inserted.
2. Check that all hot water fixtures are closed.
3. Follow the procedure on P11 "Initial operation", steps 1 through 4.
4. Make sure that the area around the appliance is well ventilated; open a window or a door if necessary. Then, operate the unit and verify that condensate is coming out of the drain pipe.  
(During normal use of the water heater, condensate will begin to discharge from the drain pipe within 30 minutes of use. However, depending on the season and/or installation site conditions, it may take longer.)

\* If water does not appear at the end of the drain line, a qualified service technician must clean the condensate line.

**! DANGER**

(Condensing model only)



Be sure to do.

After the water heater has been out of use for a long time or after replacing the drain trap with a new unit, make sure that you fill the drain trap unit with water. This is to prevent dangerous exhaust gases from entering the building. Failure to fill the drain trap unit could result in severe personal injury or death. (By performing step 4 as described above, the drain trap unit will automatically fill itself with water.)

# Regular Maintenance-1

## Inspection (Once a month)



**Caution**



High Temperature

To avoid burns, wait until the equipment cools down before draining the water. The appliance will remain hot after it is turned off.

**Check** For dust and soot in the exhaust vent or flue terminal.

**Check** For abnormal sounds during operation.

**Check** For abnormalities in external appearance, discoloration or flaws.

**Check** For water leaks from the equipment and piping.

**Check** For blockage at the drain pipe discharge.

**Check** For laundry, newspaper, timber, oil, spray cans and other combustible materials. (P4)

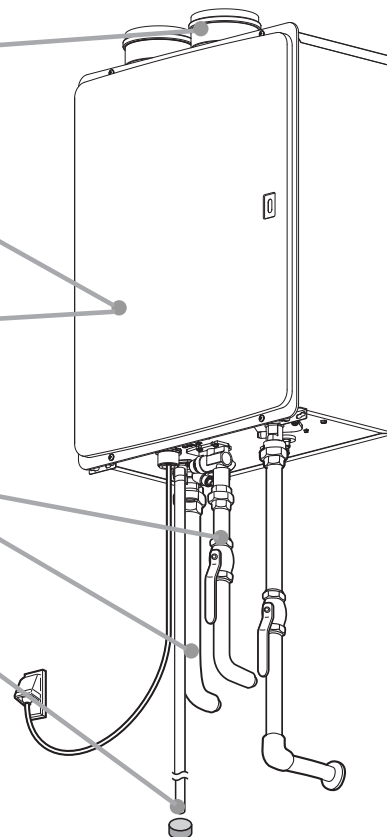

## Maintenance (Once a month)

### Equipment

The boiler casing can be cleaned using a mild liquid detergent with a damp cloth, then a dry cloth to polish.

Do not use any form of abrasive or solvent cleaner as you may damage the paintwork.

### Remote Controller

Wipe the surface with a wet cloth.

- Do not use petrol, oil or fatty detergents to clean the remote controller; deformation may occur.
- The remote controller is water resistant but not water proof. Keep it is dry as possible.

# Regular Maintenance-2

## Performance

### CAUTION



Be sure to do.

To prevent burns or scalding, turn off the power button and wait until the equipment cools before performing maintenance.

**Check** For laundry, newspaper, timber, oil, spray cans and other combustible materials.

**Check** For abnormal sounds during operation.

**Check** For abnormalities in external appearance, discoloration or flaws.

**Check** For water leaks from the equipment and piping.

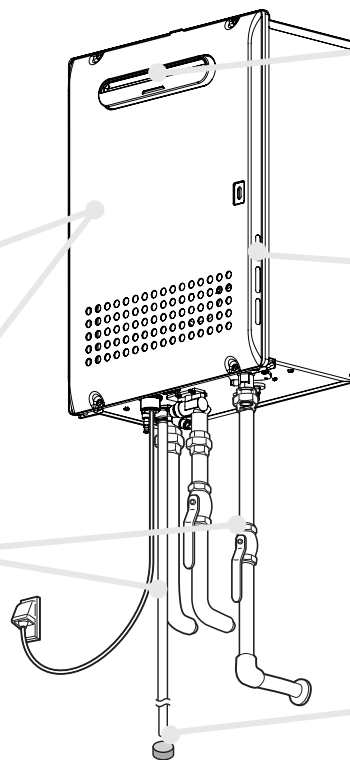

**Check** For dust and soot in the flue exhaust.

**Check** For dust or debris in the air inlet.

**Check** For blockage at the drain pipe discharge.  
Condensing model only

Ex. WHiXC56,LWHiXC56

## Periodic Maintenance

### Equipment

Wipe the outside surface with a wet cloth, then dry the surface. Use a neutral detergent to clean any stains.

### Remote Controller

Wipe the surface with a wet cloth.

- Do not use benzene, oil or fatty detergents to clean the remote controller; deformation may occur.
- The remote controller is not water resistant.



## Maintenance (Once a month)

### Water Drain Valve (with Water Filter)

If the water drain valve (with water filter) is covered with debris, the hot water may not run smoothly, or the unit may produce cold water. Check and clean the filter as explained below.

\* **To avoid burns, wait until the equipment cools down before draining the water.**  
**The appliance will remain hot after it is turned off.**

- \* Water will be discharged from the trap plug. Place a container, etc. to receive the discharged water.
- 1. Close the water supply valve.
- 2. Open all hot water fixtures.
- 3. Remove the inlet and outlet drain plugs (about 1.7 L: (L)WHiXC56 and (L)WHiC56, 0.8L: (L)WHiX49 and (L)WHi49, will drain out)
- 4. Take the water drain valve (with water filter) out of the inlet. (See illustration to right).
- 5. Clean the water drain valve (with water filter) with a brush under running water.
- 6. Replace the water drain valve (with water filter). (Take care not to lose the packing.)
- 7. Close all hot water fixtures.
- 8. Open the water supply valve and check that water does not leak from the drain plugs or water drain valve (with water filter).

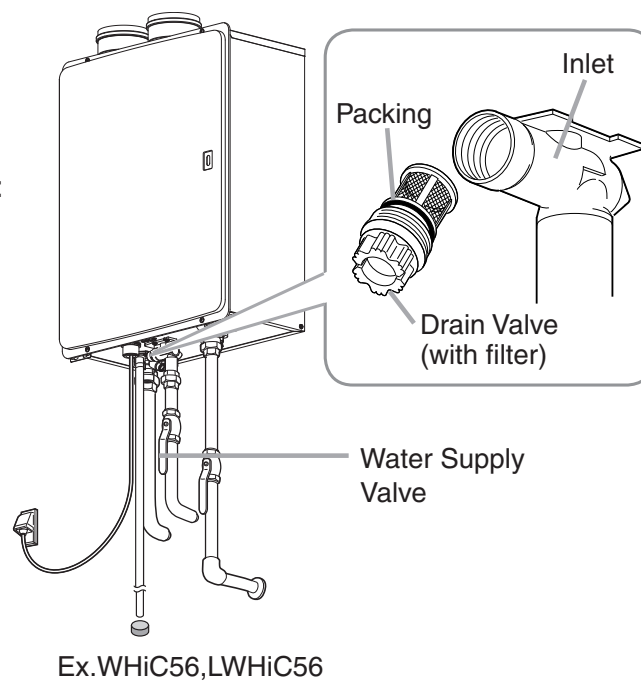

# Troubleshooting-1

## Initial Operation

Unit does not attempt to ignite when water is running.

- Check for reversed plumbing or crossed pipes.
- Check the inlet water filter. (→ p.39)

Unit attempts to ignite but fails

- Reset unit and try again. There may be air in the gas line.
- Have a professional check the gas supply pressure.

## Temperature

Hot water is not available when a fixture is opened.

- Are the gas and water supply valves fully open?
- Is the water supply cut off?
- Is the hot water fixture sufficiently open?
- Is the gas being cut off by the gas meter?  
(Can other gas devices such as stoves be used?)
- (For LPG) Is there enough gas in the tank?  
(Can other gas devices such as stoves be used?)
- Is the inlet water filter clogged? (→ p.39)
- Is the power button turned on?

No water is available when a fixture is opened.

- Is the water supply cut off?
- Is the heater frozen?

The hot water is not the correct temperature.

- Is the hot water fixture sufficiently open?

Water takes time to become hot when turning the hot water fixture

- Have you allowed enough time for the cold water in the pipes to drain out?

The water is too hot.

- Are the gas and water supply valves fully open?
- Is the water temperature setting appropriate?  
(→ p.18 and p.19)
- If the water supply temperature is high, it is possible for the temperature to be higher than the temperature set on the remote controller.
- If only a small amount of hot water is demanded, it is possible for the temperature to be higher than the temperature set on the remote controller.

The water is not hot enough.

- Are the gas and water supply valves fully open?
- Is the water temperature setting appropriate?  
(→ p.18 and p.19)

The water is cold when only a single fixture is open.	<ul style="list-style-type: none"> <li>The unit will not heat the water if the flow rate is less than 2.5 litre per minute. Open the fixture more or open other fixtures so that a greater flow passes through the unit, and the unit should begin heating again.</li> </ul>
Fluctuations in hot water temperatures.	<ul style="list-style-type: none"> <li>Set water temperature at 48°C to 50°C. This will allow you to use a higher flow of hot water thus meeting the minimum flow requirement of 2.5 L/min.</li> <li>Clean the inlet water filter of any debris (☞ p.39)</li> </ul>
Setting temperature cannot rise.	<ul style="list-style-type: none"> <li>Is the maximum temperature setting appropriate? (☞ p.24)</li> </ul>

## Amount of Hot Water

The amount of hot water at a certain fixture is not constant.	<ul style="list-style-type: none"> <li>When hot water is demanded at other fixtures, the amount available may be reduced. The maximum flow available from a 32 litre model is 32L/min., from a 28 litre model is 28 L / min. at a 25°C temperature rise.</li> <li>Pressure fluctuations and other plumbing conditions can cause the temperature and pressure at a fixture to be unstable, but it should stabilize after a short time.</li> <li>There are some types of hot water taps that discharges large volumes of hot water at first but stabilize after time.</li> <li>To keep the temperature stable, the heater limits the amount of water that can flow through it to a small amount initially, but the amount increases over time.</li> </ul>
The amount of hot water in the tub is less/more than the set amount.	<ul style="list-style-type: none"> <li>When hot water is used for other fixtures while filling the tub, the tub will not fill as much.</li> <li>If there is water in the bath already, or when filling is stopped and restarted, the bath will fill more.</li> </ul>
Flow meter alarm does not sound even when filled to the set amount.	<ul style="list-style-type: none"> <li>The flow meter alarm is set to sound when hot water is continuously discharged for the set volume of water. If mixing valves are used, or if cold water is mixed with hot water at the fixture, the bath will fill more than the setting of the bath fill function.</li> </ul>
Amount of hot water available has decreased over time.	<ul style="list-style-type: none"> <li>Is the inlet water filter clogged? (☞ p.39)</li> </ul>

(Continued)

# Troubleshooting-2

(Continued)

## Sounds

The fan can be heard after operation is stopped.  
A motor can be heard when turning the unit on or off, when opening or closing a fixture, or after the unit has been running for a while.

- These noises indicate the proper operation of devices which are designed to let the unit reignite more quickly, and ensure the water temperature is stable.

The fan can be heard when it is very cold outside.

- The fan may run to prevent freezing.

## Remote Controller

The power ON/OFF indicator does not light up.

- Has there been a power failure?
- Is the power connected properly?

The clock display shows "- : -".

- If the time is not displayed on the clock, either a power failure has occurred or power was disconnected resulting in the display showing "- : -". (→ p.23)

The water temperature changes after a power failure or when the power is disconnected.

- The temperature setting and the flow meter alarm setting may both need to be reset after a power outage.

The flow meter alarm does not sound or it sounds before the bathtub has been filled to the set amount.

- The flow meter alarm is set to sound when hot water is continuously discharged for the set volume of water. If hot water is used for other fixtures while filling the bath tub, the alarm will sound before the tub is full.
- If mixing valves are used, or if cold water is mixed with hot water at the fixture, the tub will fill more than the setting of the flow meter alarm.

The setting cannot be changed when a button is pressed.

- The remote controller is locked. While the remote controller is locked these buttons

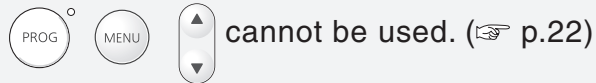

The plastic on the surface or buttons of the remote controller has torn, peeled, or air bubbles inside.

- The surface of the remote controller is affixed with a protective sheet (to prevent surface scratching, etc.) at time of shipment. This sheet can be removed or left as it is. When leaving the protective sheet on, areas frequently touched may tear or peel. However, the remote controller will not malfunction from water entering such torn or peeled areas. To restore the appearance of the remote controller surface, simply remove the protective sheet.

[For recirculation systems]  
Flame symbol <img alt="flame symbol" data-bbox="265 845 280 858"/> lights up or goes out.

- During recirculation operation, the water heater will turn on and off to keep the hot water pipes up to temperature.

## Other

The heater stops burning during operation.	<ul style="list-style-type: none"><li>• Are the gas and water supply valves fully open?</li><li>• Is the water supply cut off?</li><li>• Is the hot water fixture sufficiently open?</li><li>• Is the gas being cut off by the gas meter? (Can other gas devices such as stoves be used?)</li><li>• (For LPG) Is there enough gas in the tank? (Can other gas devices such as stoves be used?)</li></ul>
White smoke comes out of the flue exhaust on a cold day.	<ul style="list-style-type: none"><li>• This is normal. The white smoke is actually steam.</li></ul>
The hot water is turbid.	<ul style="list-style-type: none"><li>• This is harmless. Small bubbles appear as the air in the water is heated and depressurized rapidly to atmospheric pressure.</li></ul>
The water appears blue The bath tub/wash-basin has turned blue.	<ul style="list-style-type: none"><li>• Colouration to a blue colour may be noticed from small traces of copper ion contained in the water and fat (furring). However, there are not problems concerning health. Colouration of the bath tub/wash-basin can be prevented by cleaning frequently.</li></ul>
Frequent water discharge from drain pipe. (Condensing model only)	<ul style="list-style-type: none"><li>• Condensation forms inside the unit during operation and is discharged from the drain pipe.</li></ul>
A small amount of water is discharged from the pressure relief valve.	<ul style="list-style-type: none"><li>• This is normal. When the water heater is under high pressure, a small amount of water may be discharged from the pressure relief valve.</li></ul>

# Troubleshooting-3

**Please check the failure display on the remote controller or the Burner on indicator on the main body.**

In the event of a failure, the cause is notified by a blinking failure display. Please resolve the problem in accordance with the table below.

## Error Code Display Screen

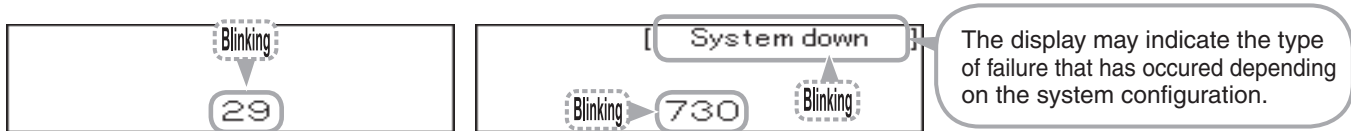

Failure display	Details of Failure	Remedy
11 F11	Fault occurs with the ignition switch at the hot water supply side.	Turn the power "Off", make sure that the gas valve is open and that the gas meter has not shut off the gas, and if this is the problem, please rectify it. Then, turn the power "On", and when the hot water tap is turned on, it is back to normal if nothing is displayed.
29 F29	Clogging of water trap	Please contact the installer or ANDREWS WATER HEATERS.
90 F90	Abnormal combustion, low gas supply pressure	Have a professional check the gas supply pressure. Please contact ANDREWS WATER HEATERS.
99 F99	Fault occurs with combustion of the unit.	Please contact ANDREWS WATER HEATERS.

## To Stop the Error Alarm

Press the  button (the indicator will turn off).

## Burner on indicator is lit (p.10 - p.12)

In the event of a failure, you are notified by the burner on indicator blinking at the front of the unit. Please resolve the problem in accordance with the table below.

Burner on indicator	Details of Failure	Remedy
Continuously blinking Lit Unlit 	• Fault occurs with the unit.	Make sure that the gas valve is open. Close the hot water tap, then reopen it, and it is back to normal if the burner on indicator is no longer lit.

### Contact our Technical Department if:

- Any other error code appears.
- An error code is indicated again after the above actions were followed.
- There are any other questions.

# Follow-up Service-1

## Requesting Service

First follow the instructions in the troubleshooting section (p.40 to p.44).  
If the error is not corrected, contact ANDREWS WATER HEATERS.

We will need to know:

- The Model** .....(check the rating plate)
- Date of purchase** .....(see the warranty)
- Details of problem** ....(flashing error codes,  
etc., in as much detail as possible)
- Your name, address, and telephone number**





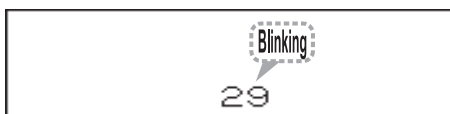

\* A request for service may be rejected if the water heater is installed in a location where working on the unit may be dangerous. Contact a plumber.

## If an error code is displayed, the model name and code can be checked





< Ex:Error code >

\* If more than one water heater is installed, this procedure cannot be used.

Operation	Screen Display	Description
<b>1</b> Press the  button.	 <p>Model code</p> <p>Product name of water heater is displayed</p>	
<b>2</b>  button is pushed again. (Return to previous screen.)	 <p>&lt;Screen display (Example)&gt;</p>	<p>* If the display is left untouched for approximately 60 seconds, it will return to the previous screen.</p>

# Follow-up Service-2

Press the  button to check the status of the system

Operation	Screen Display	Description
<b>1</b> Press the  button inside the cover.	<pre>System [ Rorc ] Active  [ 04 ] Units   [ 06 ] Pump1 [ OFF ] Online  [ 04 ] Pump2 [ ON  ]</pre> <p>&lt;Screen display (Example)&gt;</p>	<p>* Status can be checked regardless of whether the  button is ON/OFF.</p> <p>* If the  button is pushed or it is left untouched for approximately 10 minutes, it will return to the previous screen.</p>

## ● Identifying units that require service (system dependent).

Press the  button twice inside the cover.

```
Error unit
 1 - - - - 6 - -
- - - - - - - -
- - - - - - - -
```

<Screen display (Example)>

\* If you press the  button, the screen of step 1 is displayed.

If you press the  button, the screen returns to the previous screen.

## Warranty

Be sure that the warranty card is returned and includes, date of installation/commissioning, site address and other necessary items as shown.  
Read the content carefully, and keep in a safe place.

For repairs after the warranty period, please contact your local Maintenance company.

## Minimum period of time for stocking repair parts

ANDREWS WATER HEATERS will stock repair parts for this unit for a minimum of ten years after production has ceased.  
These are the parts necessary to repair or maintain this unit.



# Specifications-1

- Specifications may be changed without prior notice.
- The capacity may differ slightly, depending on the water pressure, water supply, piping conditions, and water temperature.

## Specifications

Item		Specification	
Model Name		WHiC56	LWHiC56
Type	Installation Air Supply/Exhaust	Internal, Wall Mounted Power Vented	
Ignition		Direct Ignition	
Minimum Pressure for Maximum flow		2.0 bar	
Minimum Flow Rate		2.0 L/min.	
Dimensions		61.5 cm(Height) x 46.4 cm(Width) x 24 cm(Depth)	
Weight		32 kg	
Water Holding Capacity		2.0 Litre	
Connection Sizes	Water Inlet	R 3/4"	
	Hot Water Outlet	R 3/4"	
	Gas Inlet	R 3/4"	
	Condensate Drain	R 1/2"	
Power Supply	Supply	220 - 240V AC (50Hz)	
	Consumption	75.9 W	75.9 W
		Freeze Prevention 223W	
Materials	Casing	Zincified Steel Plate/Polyester Coating	
	Flue Collar	Stainless Steel	
	Heat Exchanger	Copper Sheetting, Copper Tubing	
Safety Devices		Flame Rod, Thermal Fuse, Pressure Relief Valve, Lightning Protection Device (ZNR), Overheat Prevention Device, Freezing Prevention Device, Fan Rotation Detector	
Accessories		Anchoring Screws	

## Performance

Item		Maximum Performance	Minimum Performance
Gas Consumption (NET)	G20	54 kW	4.4 kW
	G31	54 kW	4.4 kW
Hot Water Capacity	25°C Rise	32 L/min.	
	58°C Rise	13 L/min.	
Capacity Range		2.0 - 42 L/min.	
Temperature Settings		37 - 48, 50, 55, 60, 65, 70, 75, 80, 85°C	

## Specifications-2

- Specifications may be changed without prior notice.
- The capacity may differ slightly, depending on the water pressure, water supply, piping conditions, and water temperature.

### Specifications

Item		Specification
Model Name		WHiCX56      LWHiCX56
Type	Installation Air Supply/Exhaust	External, Wall Hanging Power Vented
Ignition		Direct Ignition
Minimum Pressure for Maximum flow		2.0 bar
Minimum Flow Rate		2.0 L/min.
Dimensions		61.5 cm(Height) x 46.4 cm(Width) x 24 cm(Depth)
Weight		32 kg
Water Holding Capacity		2.0 Litre
Connection Sizes	Water Inlet	R 3/4"
	Hot Water Outlet	R 3/4"
	Gas Inlet	R 3/4"
Power Supply	Supply	220 - 240 VAC (50Hz)
	Consumption	75.9W
		Freeze Prevention
Materials	Casing	Zincified Steel Plate/Polyester Coating
	Flue Collar	Stainless Steel
	Heat Exchanger	Copper Sheeting, Copper Tubing
Safety Devices		Flame Rod, Thermal Fuse, Pressure Relief Valve, Lightning Protection Device (ZNR), Overheat Prevention Device, Freezing Prevention Device, Fan Rotation Detector
Accessories		Anchoring Screws

### Performance

Item		Maximum Performance	Minimum Performance
Gas Consumption (NET)	G20	53.5 kW	4.35 kW
	G31	54.5 kW	4.35 kW
Hot Water Capacity	25°C Rise	32 L/min.	
	58°C Rise	13 L/min.	
Capacity Range		2.0 - 42 L/min.	
Temperature Settings		37 - 48, 50, 55, 60, 65, 70, 75, 80, 85°C	

## Specifications

Item		Specification	
Model Name		WHi49	LWHi49
Type	Installation Air Supply/Exhaust	Internal, Wall Mounted Power Vented	
Ignition		Direct Ignition	
Minimum Pressure for Maximum flow		2.0 bar	
Minimum Flow Rate		2.0 L/min.	
Dimensions		60 cm(Height) x 35 cm(Width) x 28 cm(Depth)	
Weight		28 kg	
Water Holding Capacity		1.0 Litre	
Connection Sizes	Water Inlet	R 3/4"	
	Hot Water Outlet	R 3/4"	
	Gas Inlet	R 3/4"	
Power Supply	Supply	220 - 240 V AC (50Hz)	
	Consumption	75.9W	81W
		Freeze Prevention 193W	
Materials	Casing	Zincified Steel Plate/Polyester Coating	
	Flue Collar	Stainless Steel	
	Heat Exchanger	Copper Sheeting, Copper Tubing	
Safety Devices		Flame Rod, Thermal Fuse, Pressure Relief Valve, Lightning Protection Device (ZNR), Overheat Prevention Device, Freezing Prevention Device, Fan Rotation Detector	
Accessories		Anchoring Screws	

## Performance

Item		Maximum Performance	Minimum Performance
Gas Consumption (NET)	G20	49.0 kW	3.6 kW
	G31	49.0 kW	3.6 kW
Hot Water Capacity	25°C Rise	28 L/min.	
	58°C Rise	11 L/min.	
Capacity Range		2.0 - 37 L/min.	
Temperature Settings		37 - 48, 50, 55, 60, 65, 70, 75, 80, 85 °C	

# Specifications-3

- Specifications may be changed without prior notice.
- The capacity may differ slightly, depending on the water pressure, water supply, piping conditions, and water temperature.

## Specifications

Item		Specification	
Model Name		WHiX49	LWHiX49
Type	Installation Air Supply/Exhaust	External, Wall Hanging Power Vented	
Ignition		Direct Ignition	
Minimum Pressure for Maximum flow		2.0 bar	
Minimum Flow Rate		2.0 L/min.	
Dimensions		60 cm(Height) x 35 cm(Width) x 24 cm(Depth)	
Weight		26 kg	
Water Holding Capacity		1.0 Litre	
Connection Sizes	Water Inlet	R 3/4"	
	Hot Water Outlet	R 3/4"	
	Gas Inlet	R 3/4"	
Power Supply	Supply	220 - 240 VAC (50Hz)	
	Consumption	75.9W	75.9W
		Freeze Prevention 193W	
Materials	Casing	Zincified Steel Plate/Polyester Coating	
	Flue Collar	Stainless Steel	
	Heat Exchanger	Copper Sheeting, Copper Tubing	
Safety Devices		Flame Rod, Thermal Fuse, Pressure Relief Valve, Lightning Protection Device (ZNR), Overheat Prevention Device, Freezing Prevention Device, Fan Rotation Detector	
Accessories		Anchoring Screws	

## Performance

Item		Maximum Performance	Minimum Performance
Gas Consumption (NET)	G20	53.5 kW	4.35 kW
	G31	53.5 kW	4.35 kW
Hot Water Capacity	25°C Rise	28 L/min.	
	58°C Rise	12 L/min.	
Capacity Range		2.0 - 37 L/min.	
Temperature Settings		37 - 48, 50, 55, 60, 65, 70, 75, 80, 85°C	

## ErP-Information

### Product Sheet

Product name		Fastflo WHi49	Fastflo WHi49	Fastflo LWHi49	Fastflo LWHiX49	Fastflo WHiC56	Fastflo WHiC56	Fastflo LWHiC56	Fastflo LWHiCX56
Declared load profile		XXL	XXL	XXL	XXL	XXL	XXL	XXL	XXL
Water heating energy efficiency class		<b>B</b>	<b>B</b>	<b>B</b>	<b>B</b>	<b>A</b>	<b>A</b>	<b>A</b>	<b>A</b>
Water heating energy efficiency	%	79.1	79.6	81.0	79.9	91.2	91.9	90.6	92.8
Annual energy consumption	kWh <sup>(1)</sup>	51	45	44	47	50	42	50	47
	GJ <sup>(2)</sup>	24	24	23	24	21	21	21	20
Other load profiles for which the water heater is suitable to use and the corresponding water heating energy efficiency and annual electricity consumption <sup>(3)</sup>		-	-	-	-	-	-	-	-
Thermostat temperature setting	°C	40	40	40	40	40	40	40	40
Sound power level L <sub>WA</sub> indoors	dB	61	66	61	66	58	62	58	62
Ability to off-peak hours functioning <sup>(3)</sup>		-	-	-	-	-	-	-	-
Enables smart control settings <sup>(4)</sup>		-	-	-	-	-	-	-	-
(1) Electricity (2) Fuel (3) If applicable. (4) If smart control settings value is "1", the water heating energy efficiency and annual electricity and fuel consumption only relate to enabled smart control settings.									

(Continued)

# Specifications-4

(Continued)

## Technical parameters

Product name			Fastflo WHi49	Fastflo WHiX49	Fastflo LWHi49	Fastflo LWHiX49	Fastflo WHiC56	Fastflo WHiCX56	Fastflo LWHiC56	Fastflo LWHiCX56
Daily electricity consumption	$Q_{elec}$	kWh	0.233	0.205	0.202	0.216	0.227	0.194	0.227	0.215
Declared load profile			XXL	XXL	XXL	XXL	XXL	XXL	XXL	XXL
Sound power level, indoors	$L_{WA}$	dB	61	66	61	66	58	62	58	62
Daily fuel consumption	$Q_{fuel}$	kWh	30.433	30.321	29.779	30.114	26.334	26.211	26.494	25.895
Emissions of nitrogen oxides	$NO_x$	mg/kWh	42.6	32.5	48.8	36.8	42.4	41.5	42.3	50.3
Weekly fuel consumption with smart controls	$Q_{fuel, week, sm}$	kWh	-	-	-	-	-	-	-	-
Weekly electricity consumption with smart controls	$Q_{elec, week, sm}$	kWh	-	-	-	-	-	-	-	-
Weekly fuel consumption without smart controls	$Q_{fuel, week}$	kWh	213	212	208	211	184	183	185	181
Weekly electricity consumption without smart controls	$Q_{elec, week}$	kWh	2	1	1	2	2	1	2	2

# Default Settings

Items	Default setting
Clock display (unset)	--:--
Hot water temperature	40°C
Hot water volume	alarm off

Customizable Settings (P24 - 26)	Default setting	
Maximum Output Temperature	85°C	★
"Powersave dsply" and clock display	No-1	★
Brightness of the display screen when the remote controller is turned on.	Normal	★
Operation sound of remote controller	Yes	★
Notification when a failure is generated	Yes	★

★ Indicates an item that can be restored to default.  
See p.26 "Restoring Default Settings".

# Water Quality

If the heater is in a hard water area a suitable water conditioning device must be installed to prevent the build up of limescale within the heat exchanger. Heat exchangers damaged by scaling are not covered by the manufacturer's warranty.

## WATER QUALITY TABLE

Maximum levels

Description	pH	Total Dissolved solids (TDS)	Total Hardness	Chlorides	Magnesium	Calcium	Sodium	Iron
Maximum Recommended Levels	6.5 - 9.0	500 mg/liter	150 mg/liter	250 mg/liter	10 mg/liter	20 mg/liter	180 mg/liter	1 mg/liter

# Maintenance

Flushing the heat exchanger.

**1**  button is "ON".

**2** Set the temperature more than 60 degrees.

**3** Push  button again, and water heater turns off.

**4** Disconnect electrical power to the water heater.

**5** Close the shutoff valves on both the hot water and cold water lines (V3 and V4).

**6** Connect pump outlet hose (H1) to the cold water line at service valve (V2).

**7** Connect drain hose (H3) to service valve (V1).

**8** Pour chemical product used to flush heat exchanger into water (acid 8-10% of water content).

**9** Place the drain hose (H3) and the hose H2) to the pump inlet into the cleaning solution.

**10** Open both service valves (V1 and V2) on the hot water and cold water lines.

**11** Operate the pump and allow the vinegar to circulate through the water heater for at least 1 hour at a rate of 15 liters per minute.

**12** Turn off the pump.

**13** Rinse the chemical/water from the water heater as follows:

- Remove the free end of the drain hose (H3) from the pail. Place in sink or outside to drain.
- Close service valve, (V2), and open shutoff valve, (V4). Do not open shutoff valve, (V3).
- Allow water to flow through the water heater for 5 minutes.
- Close shutoff valve (V4). When unit has finished draining remove the inline filter at the cold water inlet and clean out any residue. Place filter back into unit and open valve (V4).
- Close service valve, (V1), and open shutoff valve, (V3).

**14** Disconnect all hose.

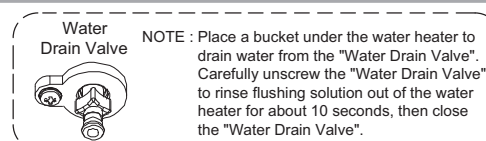

**15** Restore electrical power to the water heater.

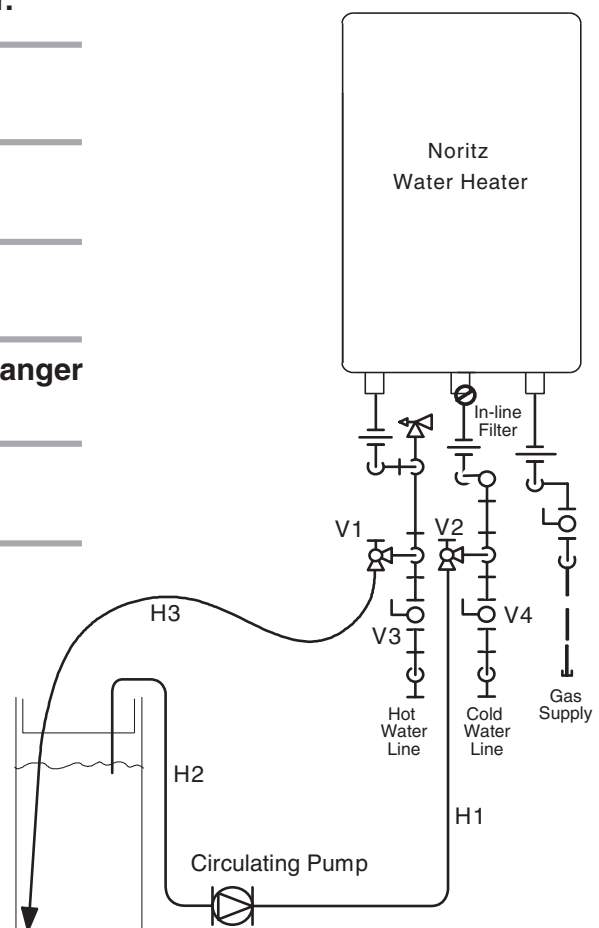
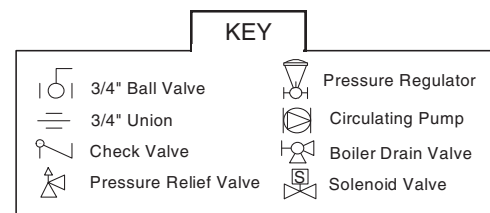



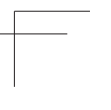
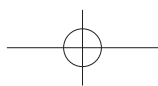
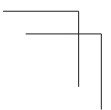
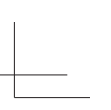
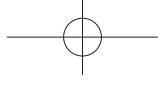
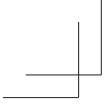

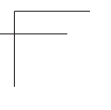
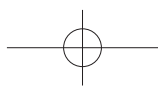
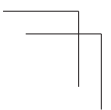
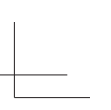
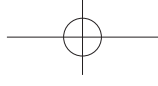
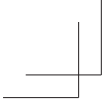

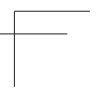
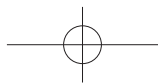
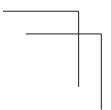
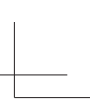
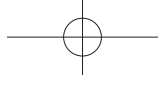
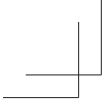



Register now to activate your warranty [www.andrewswaterheaters.co.uk/register-a-warranty](http://www.andrewswaterheaters.co.uk/register-a-warranty). Please make sure you attach proof of purchase for your warranty to be monitored.

*All descriptions and illustrations provided in this document have been carefully prepared but we reserve the right to make changes and improvements in our products which may affect the accuracy of the information contained in this leaflet. All goods are sold subject to our standard Conditions of Sale which are available on request.*

Aug 2017

Customer support

Monday - Friday

8am - 5pm

Tel 0345 070 1057

Fax 0345 070 1059

Email [service@baxicommercialdivision.co.uk](mailto:service@baxicommercialdivision.co.uk)

Website [www.andrewswaterheaters.co.uk](http://www.andrewswaterheaters.co.uk)

Twitter @AndrewsWH



Andrews. Built to perform.

part of **BAXI**  
COMMERCIAL