

Jaguar

23 kW wall hung combination boiler

GC. No. 47-047-16

28 kW wall hung combination boiler

GC. No. 47-047-17

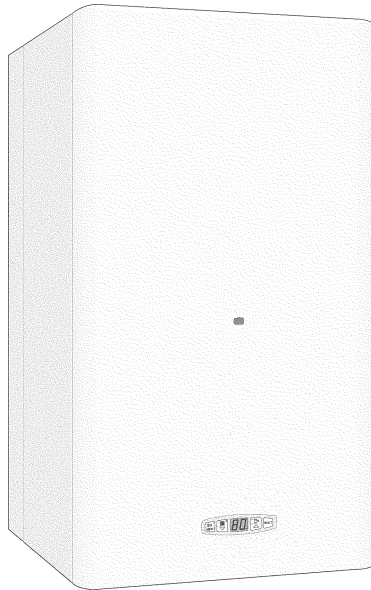

User, Installation and Servicing Instructions



*The code of practice for the installation,
commissioning & servicing of gas central heating*

This is a Cat II_{2H3P} appliance



Reference in these instructions to British Standards and Statutory Regulations/Requirements apply only to the United Kingdom. For Ireland the current edition of I.S.813 "Domestic Gas Installations" must be used.

Manufactured exclusively for Plumb Center by Hepworth Heating Division

Jaguar

Note: The boiler serial number is marked on the data label attached to the fascia behind the front panel. Refer to the 'Introduction' section for a description of the basic functions of the boiler. The 'User' section describes how to safely operate the boiler.

Users' Instructions

Important information	3
Controls and lighting	5
Timeclock instruction	7
Draining and filling	10
Heating safety valve	10
Servicing/maintenance	10
Cleaning	10
Boiler casing	10

Installation Instructions

Introduction	11
Technical data Jaguar 23	14
Technical data Jaguar 28	15
Dimensions	16
Pressure available	16
Boiler schematic	17
Installation section	18
Terminal positions	18
Heating and hot water system design	19
Boiler installation	22
Horizontal flue installation	23
Telescopic horizontal flue installation	24
Vertical flue installation	25
Flue configurations	26
Electrical connection	26
Commissioning	28
Instruct the user	31

Servicing Instructions

Routine cleaning and inspection	31
Replacement of parts	34
Schematic wiring diagram	40
Fault finding	41
Conversion to LPG	42
Spare parts	44

Mandatory warning for CE countries

WARNING, these appliances were designed, approved and inspected to meet the requirements of the English market. The identification plate located on the inside of the appliance **certifies the origin** where the product was manufactured and the **country** for which it is intended.

If you see any exception to this rule, please contact your nearest stockist.

Thank you in advance for your assistance.

Important Information

Testing and Certification

This boiler is tested and certificated for safety and performance. It is therefore important that no alterations are made to the boiler, without permission.

Any alteration not approved could invalidate the certification, boiler warranty and may also infringe the current issue of the Statutory Requirements. The requirements are: The installation of the boiler must be carried out by a competent person in accordance with the current rules in force in the countries of destination at the time of installation. Manufacture's instructions supplied. Manufacture's instructions must not be taken as overriding statutory requirements.

CE Mark

This boiler meets the requirements of Statutory Instrument No. 3083 The boiler (Efficiency) Regulations, and therefore is deemed to meet the requirements of Directive 92/42/EEC on the efficiency requirements for new hot water boilers fired with liquid or gaseous fuels.

Type test for purposes of Regulation 5 certified by: Notified body 0063.

Product/production certified by: Notified body 0063.

The CE mark on this appliance shows compliance with:

1. Directive 90/396/EEC on the approximation of the laws of the Member States relating to appliances burning gaseous fuels.
2. Directive 73/23/EEC on the harmonization of the Laws of the Member States relating to the electrical equipment designed for use within certain voltage limits.
3. Directive 89/336/EEC on the approximation of the Laws of the Member States relating to electromagnetic compatibility.

Substances Hazardous to Health

Under section 6 of the Health and Safety at Work Act 1974, we are required to provide information on substances hazardous to health.

The adhesives and sealants used in this appliance are cured and give no known hazard in this state.

INSULATION PADS/CERAMIC FIBRE, GLASSYARN, MINERAL WOOL

These can cause irritation to skin, eyes and the respiratory tract.

If you have a history of skin complaint you may be susceptible to irritation. High dust levels are usual only if the material is broken.

Normal handling should not cause discomfort, but follow normal good hygiene and wash your hands before eating, drinking or going to the lavatory.

If you do suffer irritation to the eyes or severe irritation to the skin seek medical attention.

The insulation is composed of non-combustible material.

Spare Parts

REMEMBER, When replacing a part on the appliance, use only spare parts that you can be assured conform to the safety and performance specification that we require. Do not use reconditioned or copy parts that have not been clearly authorised.

Manual Handling Guidance

During the appliance installation it will be necessary to employ caution and assistance whilst lifting as the appliance exceeds the recommended weight for a one man lift.

In certain situations it may be required to use a mechanical handling aid.

Take care to avoid trip hazards, slippery or wet surfaces.

USERS INSTRUCTIONS

The **Jaguar** is a wall mounted combination boiler providing central heating and instantaneous domestic hot water.

These instructions should be carefully followed for the safe and economical use of your boiler.

Gas leak or fault

If a gas leak or fault exists or is suspected, turn the boiler and gas supply off and consult the local gas company or your Installer/Service provider.

In case of power supply failure

The boiler no longer operates.

As soon as power supply is restored, the boiler will restart automatically.

In case of loss of water in the system

CAUTION: The boiler is installed as part of a sealed system which must only be drained and filled by a competent person.

If the pressure LED diod (2) flashes the pressure in CH system is less than 0.8 bar and the system must be filled up immediately.

Important notice: A central heating system cannot operate satisfactorily unless it is properly filled with water and unless the air initially contained in the piping systems has been properly bled off. If these conditions are not satisfied, air noise will occur within the system and the boiler may fail to operate.

Air in the heating system

Persistent air in the heating system may indicate leaks in the system or corrosion taking place. Call your Installer /Service provider.

Overheating safety

In the event of problem, the overheat safety device causes safety shutdown of the boiler. If this happens, call your Installer/Service provider.

Heating system controls

It is recommended that a programmer and room thermostat control the boiler.

Thermostatic radiator valves may be installed, however they must not be fitted in a room where the room thermostat is located.

Note: All systems must have at least one radiator not fitted with a thermostatic valve.

Note: For further information, see the supplementary guide provided by the DTLR "Domestic heating & hot water guide" to the building regs. 2001 - part L1 and the references:

1) GiL 59, 2000: Central heating system specification (CheSS) and

2) GPG 302, 2001: Controls for domestic central heating system and hot water. BRECSU.

CONTROLS AND LIGHTING

The control panel is located at the lower front of the boiler casing. The controls on this panel allow the boiler to be started, shut down, controlled and monitored during use, see diagram 1.

The following information is displayed:

- < Actual heating temperature (°C) - LED (3) lights on
displayed during standby
- < Actual domestic hot water temperature (°C) - LED (5) lights
displayed during hot water demand
- < System pressure (bar) – LED (2) lights
for 25 sec after Bar/Mode button is pressed
- < Diagnostic messages – displayed letter F and numbers from 0 to 4

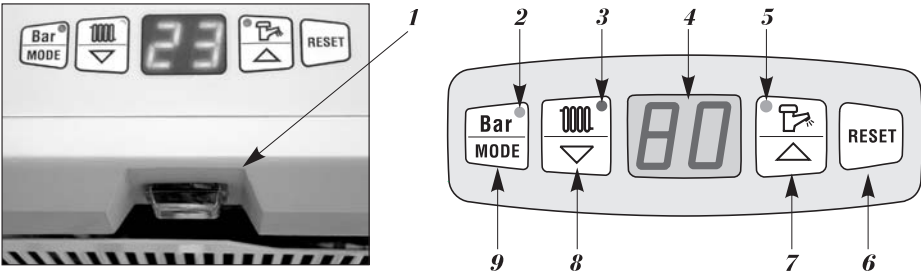

Controls:

- 1 – mains on/off switch
- 2 – system pressure LED
- 3 – central heating LED
- 4 – display
- 5 – domestic hot water LED

- 6 – reset button
- 7 – increase button
- 8 – decrease button
- 9 – pressure/mode button

Diagram 1

The Bar/Mode button functions

- 1st press of button – the system pressure is displayed in bar
LED (2) lights
- 2nd press of button – hot water adjusting mode
LED (5) flashes
- 3rd press of button – heating water adjusting mode
LED (3) flashes
- 4th press of button – reverts to standby mode

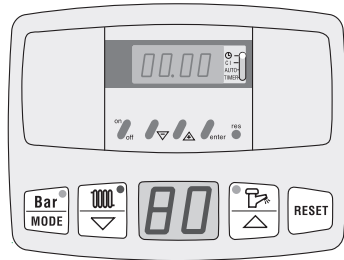

To start the boiler

Switch on the mains switch (display will light up). The version of the software used is displayed for 2 sec.

Place the slide switch on TIMECLOCK to 'RUN' position. Use the 'On/Off' button to set the boiler 'On'. For programming see chapter 'TIMECLOCK INSTRUCTIONS'.

To stop the boiler

Switch off the mains switch (display will go out)

If the boiler is to be out of operation for a long period, turn off the gas service cock.

Boiler setting

All parameters are adjustable by means of 3 buttons, pushing the RESET button restarts the boiler.

Note: Buttons must be pressed in the middle.

Make sure that:

- The boiler is connected to the electrical supply.
- The boiler gas service cock is open.
- The CH system is filled up and pressurized between 1 and 2 bar.

The boiler is now ready to start.

Domestic hot water setting

- Press Bar/Mode button until LED (5) flashes.
- Using buttons (7) and (8) set the desired hot water temperature

Setting steps: 40, 42, 45, 48, 50, 52, 55, 58, 60 °C

- Set '–' if hot water is not required.
- Press Bar/Mode button to save new setting.

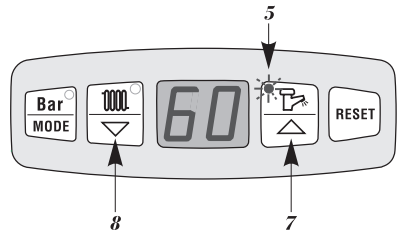

Heating setting / summer mode setting

- Press Bar/Mode button until LED (3) flashes.
 - Using buttons (7) and (8) set the desired heating temperature
- Setting steps: 45, 50, 55, 60, 65, 70, 75, 80, 85 °C*
- Set '–' if only hot water is required (summer mode).
 - Press Bar/Mode button to save new setting.

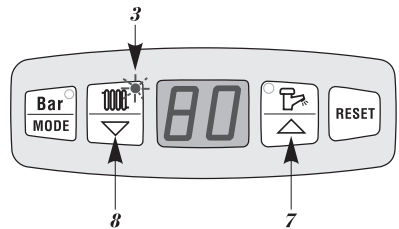

The heating will operate according to the requirements of the timeclock and/or room thermostat if fitted or, will operate according to the system requirements. Domestic hot water (DHW) always has priority over central heating (CH).

Note: All new settings are stored by pressing Bar/MODE button. If Bar/MODE button is not pressed for 20 sec the display reverts to standby mode and old settings are retained.

Helpfull hint

If you get confused and wish to start again, switch boiler off, press and hold button (8) and switch boiler on by main switch. The boiler will revert to the internal factory set programme (heating temperature 80 °C, hot water temperature 50 °C, maximum heat output).

Safety lockout

In the event of a safety lockout, the digital display will show 'F1'.

Reset boiler by pressing the RESET button.

IMPORTANT: If safety lockout occurs frequently, or if any other fault is indicated, contact your Installer/Service Provider.

CLOCK - INSTRUCTIONS FOR USE

General Description

The timeclock has an internal, factory set programme which switches the boiler 'On' and 'Off' three times a day as below.

1st ON 06.30
1st OFF 08.30
2nd ON 12.00
2nd OFF 12.00
3rd ON 16.30
3rd OFF 22.30

Note that the 2nd 'On' and 'Off' preset time will not bring the boiler on. In most cases this may not be needed at these times but can be programmed by the user if desired.

It also has an advance feature, a hold or holiday feature, details on how to set these are given further on in these instructions.

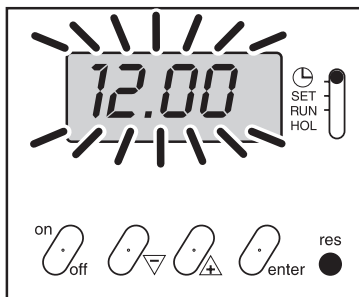

Diagram I

Setting the Time

With the electrical supply to the boiler switched on, place the slide switch to 'r'.

Press the reset 'res' button for a few seconds, using a pointed object, such as a pencil. When released the display will begin to flash, see **diagram I**. Using the '+' and '-' buttons, set the display to the correct time in twenty four hour format, for example, 13.00 for 1pm, see **diagram II**.

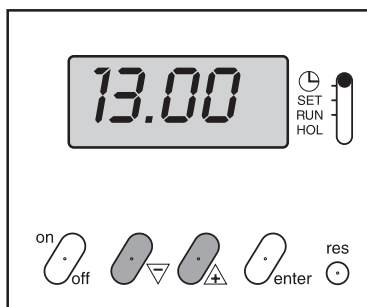

Diagram II

Helpful Hint

The '+' and '-' buttons are used to change times. Press and release for small changes. If you press and hold down the time will change quickly.

To Set the Programme 'On' and 'Off' Times

At this stage, if you want to use the internal, factory set, programmes simply place the slide switch to 'Run'. The display will show the current time. The 'On' or 'Off' symbol will be shown according to the time of day.

To Override or Advance the Timeclock

To advance the time clock operation, that is, switch the heating 'On' when it is 'Off' or the other way round, press the 'On/Off' button. The timeclock will switch the heating 'On' or 'Off' as desired and the 'On' or 'Off' symbol will flash to show that it has been overridden. See **diagram III**.

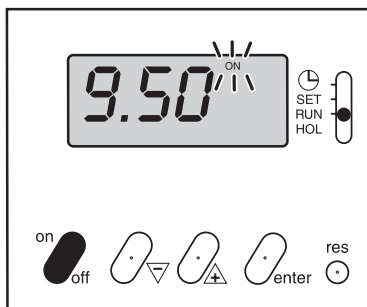

Diagram III

Note. The boiler will stay 'On' or 'Off', as selected, until the timeclock programme reaches its next 'On' or 'Off' time. From then on, the timeclock will switch the boiler 'On' and 'Off' according to the internal programme. When the boiler is again controlled by the internal programme the 'On' or 'Off' symbol will stop flashing. The timeclock operation can be overridden in this way at any time.

**To Set Your Own Programme
'On' and 'Off' Times**

Note. The timeclock can be set to give a minimum of one and a maximum of three 'On' and 'Off' times.

Place the slide switch to 'SET'. The display will show the first 'On' time, see **diagram IV**.

Using the '+' and '-' buttons, change the first 'On' time to the time you require. Press the 'Enter' button twice. This stores the new time and shows it to confirm it has been stored in the timeclock memory.

Press the 'Enter' button again. The display will show the first 'Off' time, see **diagram V**.

Using the '+' and '-' button, change the first 'Off' time to the time you require. Press the 'Enter' button twice. The display will show the first 'On' time. Press the 'Enter' button again. The display will now show the first 'Off' time you have just entered.

Repeat the above for the remaining 'On' and 'Off' times.

When you have set the 'On' and 'Off' times you require, place the slide switch to 'RUN'.

Note. If you do not want to set all three 'On' and 'Off' times, follow the above instructions, but, after you have set the times you require, set the other times to show a series of dashes, using the '+' and '-' button, see **diagram VI**.

The series of dashes are between times 23.59 and 0.00.

Helpful Hint.

If you get confused and wish to start again, press the reset 'res' button and the timeclock will go back to the internal factory set programme. You can now reset the current time and start again.

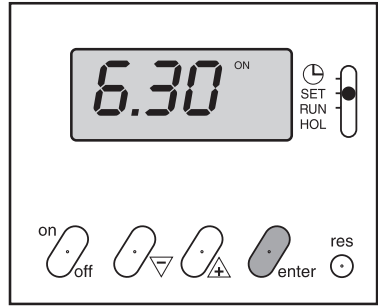

Diagram IV

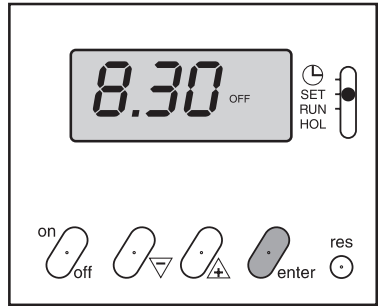

Diagram V

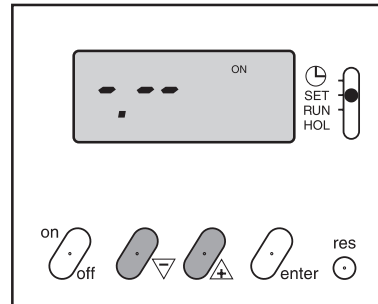

Diagram VI

To Check the Programme 'On' and 'Off' Times

The programmed 'On' and 'Off' times can be checked at any time by moving the slide switch from 'RUN' to 'SET'.

Successive presses of the 'Enter' button will then show the 'On' and 'Off' times.

Always return the slide switch to 'RUN' to return to normal timed working.

To Set the 'Hold' or 'Holiday' Feature

The timeclock has a 'Hold' or 'Holiday' feature which can be set, if required, to keep the central heating 'On' or 'Off' for a period between one hour and twenty seven days. This can be used, for example to keep the central heating 'Off' during a holiday. After the programmed time has gone by, the boiler returns to its normal programmes.

To set the 'Hold' or 'Holiday' feature carry on as follows:

Place the slide switch to 'HOL', the letter 'h' will appear on the display, see **diagram VII**.

Using the '+' and '-' buttons, set the 'Hold' time required.

After a hold period of twenty three hours has been exceeded, the 'h' symbol on the display will change to a 'd'. The 'hold' time will now be in days, instead of hours, see **diagram VIII**.

Use the 'On/Off' button to set the boiler to the required operation during the 'Hold' period.

Place the slide switch to 'RUN'. The 'On' and 'Off' symbol will flash on the display to show that it has been overridden, see **diagram III**.

After the programmed hold time, the boiler will return to normal timed working.

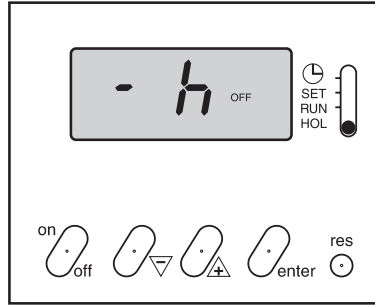

Diagram VII

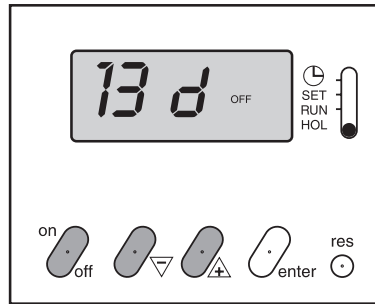

Diagram VIII

DRAINING AND FILLING

CAUTION: The boiler is installed as part of a sealed system which must only be drained and filled by a competent person.

If the pressure drops to 0.8 bar the pressure LED on the Bar/MODE button starts to flash. The boiler will continue to work, but the LED warns that pressure in the CH system is on the low limit and CH system must be filled. To fill the system, open the tap on the filling loop below the boiler. Press the Bar/MODE button to read the system pressure. When the pressure is between 1 and 2 bar, close the tap.

Note: If there is persistent loss of system pressure, you must consult your Installer/Service Provider.

BOILER DRAIN POINT

The boiler drain point is situated inside the boiler behind the control panel. To gain access remove the front panel and drop down the control panel. Turn anti-clockwise to open.

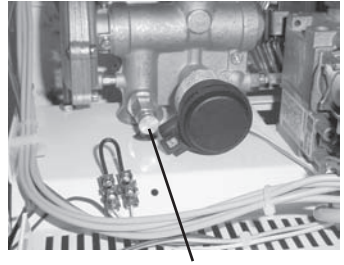

BOILER DRAIN POINT

HEATING SAFETY VALVE

CAUTION: A safety valve with a discharge pipe is fitted to this boiler.

The valve **MUST NOT BE TOUCHED** except by a competent person. If the valve discharges at any time, switch the boiler off and isolate it from the electrical supply. Contact your Installer/Service Provider.

SERVICING/MAINTENANCE

To ensure the continued efficient and safe operation of the boiler, it is recommended that it is checked and serviced at regular intervals. The frequency of servicing will depend upon the installation conditions and usage but, in general, once a year should be enough.

If this appliance is installed in a rented property in the UK there is a duty of care imposed on the owner of the property by the current issue of The Gas Safety (Installation and Use) Regulations, Section 35.

CLEANING

The boiler casing can be cleaned with a damp cloth followed by a dry cloth to polish. Do not use abrasive or solvent cleaners.

BOILER CASING

CAUTION: Do not remove or adjust the casing in any way, as incorrect fitting may result in faulty operation.

If in doubt, contact your Installer/Service Provider.

INSTALLATION INSTRUCTIONS

Introduction

The Jaguar is a wall mounted combination boiler providing central heating and instantaneous domestic hot water.

The boiler is of the II_{2H3P} category for use with Natural gas (G20) as distributed in the United Kingdom, or with Propane gas (G31) with the appropriate conversion kit.

Conversion kit:

Conversion	Jaguar 23	Jaguar 28
Natural gas (G20) to (G31)	1/08/730	1/08/731

Modification must only be carried out by a competent person.

Boilers burning LPG or similar gases MUST NOT be fitted in basements or below ground level.

These instructions should be carefully followed for the safe and economical use of your boiler.

The boiler has a fan assisted, balanced, flue which both discharges the product of combustion to, and draws the combustion air from the outside of the building.

Accessories

A range of accessories are available including, vertical flue components. For further information, contact you nearest Plumb Center branch.

Electrical supply

WARNING: The boiler must be earthed.

All system components shall be of an approved type and shall be connected in accordance with the current issue of BS7671 and any applicable local regulations.

External wiring must be correctly earthed, polarised and in accordance with the relevant standards.

In GB this is BS6891.

In IE this is the current edition of I.S.813 "Domestic Gas Installations".

Connection of the boiler and system controls to the mains supply must be through a common isolator and must be fused 3A, maximum. This method of connection must be by a fused double pole isolating switch, with a minimum contact separation of 3mm on both poles. The switch should be readily accessible and preferably adjacent to the appliance. It should supply the appliance only and be easily identifiable as so doing. Alternatively, an unswitched shuttered socket outlet and 3A fused 3 pin plug, both to the current issue of BS1363 may be used provided that they are not used in a room containing a bath or shower.

Wiring to the boiler must be PVC 85°C insulated cable, not less than 0.75mm² (24/0.20mm).

Flue

Do not obstruct the outside terminal of the flue.

Boiler controls

The control panel, located at the lower front of the boiler, allows the boiler to be started, shut down, controlled and monitored during use, refer to '**Users Instructions**'.

Safety valve discharge

WARNING: It must not discharge above an entrance or window or any type of public access area.

Connect the safety valve discharge pipe to the valve, the discharge must be extended using not less than 15 mm o.d. pipe, to discharge in a visible position outside the building, facing downward, preferably over a drain. The pipe must have a continuous fall and be routed to a position so that any discharge of water, possibly boiling or steam, cannot create any danger to persons, damage to property or external electrical components and wiring. Tighten all pipe connection joints.

Gas connection

The gas installation shall be in accordance with the relevant standards.

In GB this is BS6891.

In IE this is the current edition of I.S.813 "Domestic Gas Installations".

The supply from the governed meter must be of adequate size to provide a constant inlet working pressure of 20 mbar for Natural gas (37 mbar for Propane).

To avoid low pressure problems, it is recommended that the supply is taken to the boiler using 22 mm pipe as far as possible.

On completion, the gas installation must be tested using the pressure drop method and purged in accordance with the current issue of BS6891.

Gas Safety (Installation and Use) Regulations

In your interests and that of gas safety, it is the law that **ALL** gas appliances are installed and serviced by a competent person in accordance with the above regulations.

Statutory requirements

The appliance is suitable only for installation in GB and IE and should be installed in accordance with the rules in force.

In GB the installation of the boiler must be carried out by a competent person as described in the following regulations:

The manufacturer's instructions supplied.

The Gas Safety (Installation and Use) Regulations.

The appropriate Buildings Regulations either The Building Regulations, The Building Regulations (Scotland), The Building Regulations (Northern Ireland).

The Water Fittings Regulations or Water byelaws in Scotland.

The Health and Safety at Work Act, Control of Substances Hazardous to Health (COSHH).

The Current I.E.E. Wiring Regulations.

Where no specific instructions are given, reference should be made to the relevant British Standard Code of Practice.

In IE, the installation must be carried out by a competent person and installed in accordance with the current edition of I.S.813 "Domestic Gas Installations", the current Building Regulations and reference should be made to the current ETCI rules for Electrical Installation.

In GB the following Codes of Practice apply:

BS4814, BS6798, BS5440 Part 1 and 2, BS5546 Part 1, BS5449, BS6891, BS6700, BS7074 Part 1 and 2, BS7593, BS7671.

In IE: I.S.813, BS5546, BS5449, BS7074, BS7593.

Manufacturer's instructions must not be taken as overriding statutory requirements.

Sheet metal parts

WARNING: When installing or servicing this boiler, care should be taken when handling the edges of sheet metal parts to avoid the possibility of personal injury.

Installing the boiler

This boiler is not suitable for outdoor installation.

This boiler may be installed in any room, although particular attention is drawn to the installation of a boiler in a room containing a bath or a shower where reference must be made to the relevant requirements.

In GB this is the current I.E.E. WIRING REGULATIONS and BUILDING REGULATIONS. In IE reference should be made to the current edition of I.S.813 "Domestic Gas Installations" and the current ETCI rules.

Prior to installing the boiler, the system must be thoroughly flushed to eliminate any foreign bodies and contaminants such as filings, solder, particles, oil, grease etc.

Note: Solvent products could cause damage to the system.

Data

The Seasonal Efficiency Domestic Boilers UK (SEDBUK) is (D) JAGUAR 23 =78.7% JAGUAR 28 = 79.3%. The value is used in the UK Government's Standard Assessment Procedure (SAP) for energy rating of dwellings. The test data from which it has been calculated have been certified have been certified by B.S.I.

Boilers in a compartment

Where the installation of the boiler will be in an unusual position, special requirements are needed, the current issue of BS6798 gives detailed guidance on these requirements.

A compartment used to enclose the boiler must be designed and constructed specifically for this purpose. An existing cupboard or compartment modified for the purpose may be used. Details of essential requirements for cupboard or compartment design are given in the current issue of BS6798.

The doorway opening should be of sufficient size to allow for easy removal of the boiler.

Where the boiler is fitted in a cupboard or compartment, permanent high and low level ventilation must be provided. The minimum ventilation areas required are given in Table 1.

Do not use the cupboard or compartment for storage.

VENTILATION REQUIREMENTS		HIGH LEVEL VENT AREA		LOW LEVEL VENT AREA	
		cm ²	in ²	cm ²	in ²
VENTILATION FROM ROOM OR SPACE	MODEL				
	23kW	258	40	258	40
	28kW	303	47	303	47
VENTILATION FROM OUTSIDE	23kW	129	20	129	20
	28kW	152	24	152	24

JAGUAR 23 – TECHNICAL DATA

CE Certification	n°	0063BL3573
Class		II _{2H3P}
Type		C ₁₂ , C ₃₂
Gas type	G20	G31
Max. / min. Heat Input	kW	25.8 / 11.4 25.8 / 11.4
Max. / min. Heat Output	kW	23.0 / 9.4 23.0 / 9.4

EFFICIENCY (PCI)

Nominal efficiency	%	81.6
Efficiency at 30% load	%	79.7

HEATING

Temperature range	°C	45 – 85
Expansion vessel	l	5
Expansion vessel pressure	bar	1
Max. working pressure	bar	3
Max. system temperature	°C	85
Max. system capacity	l	100

HOT WATER

Flow rate at 30°C temperature rise	l/min	11.2
Flow rate at 35°C temperature rise	l/min	9.6
Min. water flow	l/min	2
Max. / min. supply pressure	bar	6 / 1
Temperature range	°C	40 – 60

ELECTRICAL DATA

Voltage/frequency	V/Hz	~230/50
Current	A	0.6
Power	W	135
Level of protection	IP	IP 44

DIMENSIONS

Width / Height / Depth	mm	410 / 740 / 320
Weight	kg	35

CONNECTIONS

Heating flow / return	mm	22
Domestic Water inlet / outlet	mm	15
Gas	mm	22
Flue products outlet / air inlet →	mm	horiz. 60/100, vert. 80/125
Horizontal flue length min/max	m	0.3 – 4
Vertical flue length min/max	m	0.5 – 9

GAS SUPPLY PRESSURE

Burner pressure	mbar	3 – 15.7 7 – 35.6
Nominal pressure	mbar	20 37
Injectors diameter	→ mm	1.07 0.68

GAS CONSUMPTION

Q max / Q min	m ³ /h	2.7 / 1.2 1.9 / 0.8 kg/h
Air flow	m ³ /h	100 100

JAGUAR 28 – TECHNICAL DATA

CE Certification	n°	0063BL3573
Class		II ₂ H ₃ P
Type		C ₁₂ , C ₃₂
Gas type	G20	G31
Max. / min. heat input	kW	30.3/13.1 30.3/13.1
Max. / min. heat output	kW	27.6/11.0 27.6/11.0

EFFICIENCY (PCI)

Nominal efficiency	%	82.3
Efficiency at 30% load	%	80.5

HEATING

Temperature range	°C	45 – 85
Expansion vessel	l	7
Expansion vessel pressure	bar	1
Max. working pressure	bar	3
Max. system temperature	°C	85
Max. system capacity	l	130

HOT WATER

Flow rate at 30°C temperature rise	l/min	13.0
Flow rate at 35°C temperature rise	l/min	11.1
Min. water flow	l/min	2.7
Max. / min. supply pressure	bar	6 / 1
Temperature range	°C	40 – 60

ELECTRICAL DATA

Voltage / frequency	V/Hz	~230 / 50
Current	A	0.63
Power	W	145
Level of protection	IP	IP X4D

DIMENSIONS

Width / height / depth	mm	450 / 800 / 330
Weight	kg	40.5

CONNECTIONS

Heating flow / return	mm	22
Domestic Water inlet / outlet	mm	15
Gas	mm	22
Flue products outlet / air inlet →	mm	horiz. 60/100, vert. 80/125
Horizontal flue length min. – max.	m	0.5 – 3
Vertical flue length min. – max.	m	1 – 9

GAS SUPPLY PRESSURE

Burner pressure	mbar	2.5 – 14.0 4.9 – 36.0
Nominal pressure	mbar	20 37
Injectors diameter	→ mm	1.2 0.73

GAS CONSUMPTION

Q max / Q min	m ³ /h	3.2 / 1.4 2.2 / 1.1 kg/h
Air flow	m ³ /h	135 135

DIMENSIONS AND PRESSURE AVAILABLE

Jaguar 23

A	740
B	410
C	45
D	200
E	75
F	214
H	162
I	95
J	147
K	90

Jaguar 28

A	800
B	450
C	65
D	225
E	83
F	228
G	180
H	330
I	105
J	160
K	70

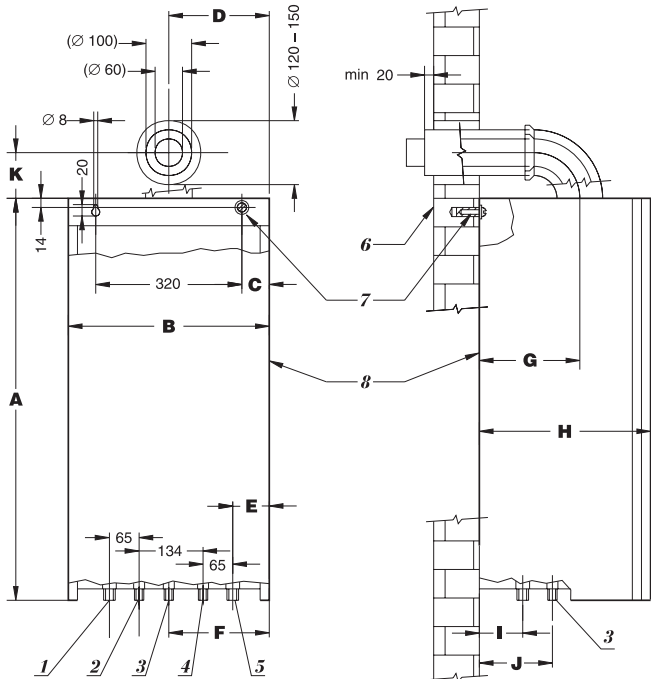

FRONT VIEW

Diagram 2

- | | |
|--|--|
| 1 – Heating flow (pipe diameter 22 mm) | 5 – Heating return (pipe diameter 22 mm) |
| 2 – Hot water outlet (pipe diameter 15 mm) | 6 – Wall |
| 3 – Gas inlet (pipe diameter 22 mm) | 7 – Wall fixings |
| 4 – Cold water mains inlet (pipe diameter 15 mm) | 8 – Outer cover |

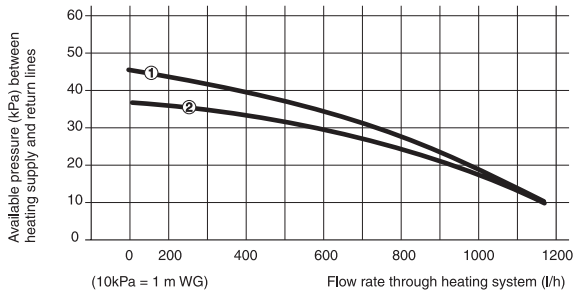

- ① Bypass fully shut
 ② Bypass open

Diagram 3

BOILER SCHEMATIC

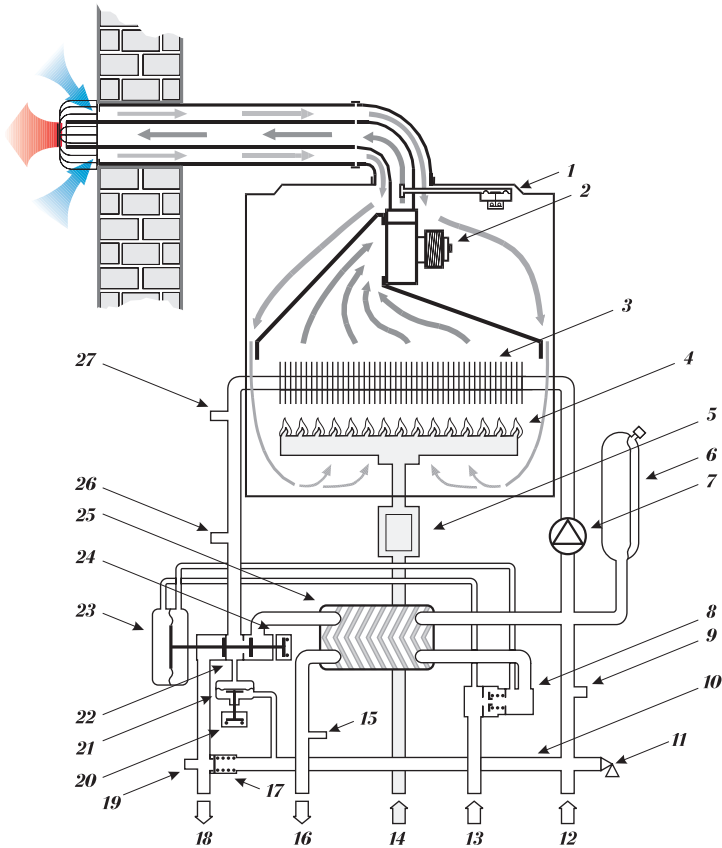

- | | |
|--------------------------------|------------------------------------|
| 1 – Air pressure switch | 16 – DHW outlet |
| 2 – Fan | 17 – Automatic by-pass |
| 3 – Heat exchanger | 18 – Heating flow |
| 4 – Burner | 19 – Drain |
| 5 – Gas valve | 20 – Microswitch |
| 6 – Expansion vessel | 21 – Loss of water pressure switch |
| 7 – Pump | 22 – 3-way valve |
| 8 – Water flow sensor | 23 – Differential valve |
| 9 – Pressure gauge connection | 24 – Microswitch |
| 10 – By-pass pipe | 25 – Secondary heat exchanger |
| 11 – Safety valve | 26 – CH temperature sensor |
| 12 – Heating return | 27 – High limit thermostat |
| 13 – Domestic cold water inlet | |
| 14 – Gas inlet | |
| 15 – DHW thermistor | |

Diagram 4

INSTALLATION SECTION

Clearances

To allow for servicing, the boiler should be installed with the following clearances:

- 50 mm either side of the boiler
- 600 mm to the front of the boiler
- 300 mm below the boiler
- 200 mm above the boiler

TERMINAL POSITION

The minimum acceptable siting dimensions for the terminal from obstructions, other terminals and ventilation openings are shown in diagram 5. For Ireland the minimum distances for flue terminal positioning must be those detailed in I.S.813 "Domestic Gas Installations".

Diagram 5

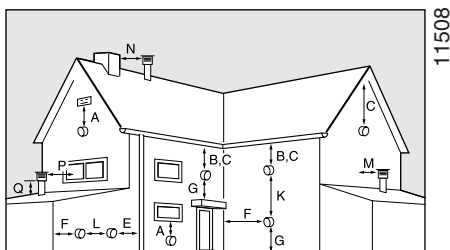

UNDER CAR PORT etc.

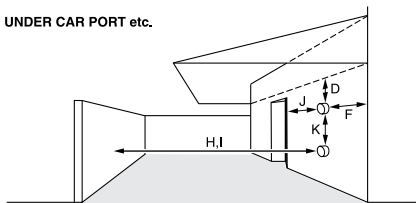

Minimum dimensions (in mm) for the positioning of flue terminals

HORIZONTAL FLUES

A	DIRECTLY BELOW, ABOVE OR HORIZONTALLY TO AN OPENING, AIR BRICK, OPENING WINDOWS, AIR VENT, OR ANY OTHER VENTILATION OPENING	300
B	BELOW GUTTER, DRAIN/SOIL PIPE	75
C	BELOW EAVES	200
D	BELOW A BALCONY OR CAR PORT	200
E	FROM VERTICAL DRAIN PIPES AND SOIL PIPES	150
F	FROM INTERNAL / EXTERNAL CORNERS OR TO A BOUNDARY ALONGSIDE THE TERMINAL	300
G	ABOVE ADJACENT GROUND OR BALCONY LEVEL	300
H	FROM SURFACE OR A BOUNDARY FACING THE TERMINAL	600
I	FACING TERMINALS	1200
J	FROM OPENING (DOOR/WINDOW) IN CAR PORT INTO DWELLING	1200
K	VERTICAL FROM A TERMINAL	1500
L	HORIZONTALLY FROM A TERMINAL	300

VERTICAL FLUES

M	FROM ADJACENT WALL TO FLUE	300
N	FROM ANOTHER TERMINAL	600
P	FROM ADJACENT OPENING WINDOW	1000
Q	ABOVE ROOF LEVEL	300

HEATING SYSTEM DESIGN

The installation of the boiler must comply with the requirements of the current issue of BS6798, in Ireland, refer also to the current issue of I.S.813 "Domestic Gas Installations".

In GB it is necessary to comply with the Water Supply (Water Fittings) Regulations 1999 (for Scotland, the Water Byelaws 2000, Scotland).

To comply with the Water regulations your attention is drawn to: The Water Regulations guide published by the Water Regulations Advisory Service (WRAS) gives full details of the requirements.

In IE the requirements given in the current edition of I.S.813 "Domestic Gas Installations" and the current Building Regulations must be followed.

The **Jaguar** is compatible with any type of sealed system installation, i.e. radiators, fan convectors etc.

Pipe sectional areas shall be determined in accordance with normal practices, using the pump curve, refer to '**Technical Data**'. The distribution system shall be calculated in accordance with the output requirements of the actual system, not the maximum output of the boiler. However, provision shall be made to ensure sufficient flow so that the temperature difference between the flow and return pipes is less than or equal to 20 °C. The minimum flow is **500 l/h**.

The piping system shall be routed so as to avoid any air pockets and facilitate permanent venting of the installation. Bleed fittings shall be provided at every high point of the system and on all radiators.

The total volume of water permitted for the heating system depends, amongst other things, on the static head in the cold condition. The expansion vessel on the boiler is pressurised at 1 bar (corresponding to a static head of 10 m wg.) and allows a maximum system volume of 100 litres (Jaguar 23), 130 litres (Jaguar 28) for an average temperature of 75 °C and a maximum service pressure of 3 bar. This pressure setting can be modified at commissioning stage if the static head differs.

Note: The expansion vessel volume depends on the total water system volume and the initial system design pressure. Guidance on vessel sizing is also given in the current issue of BS5449 and BS7074 Part 1, for IE refer to the current edition of I.S.813 "Domestic Gas Installations".

Provision shall be made for a drain valve at the lowest point of the system.

Thermostatic radiator valves may be installed, however they must not be fitted in a room where the room thermostat is located.

Note: All systems must have at least one radiator not fitted with a thermostatic valve.

Note: For further information, see the supplementary guide provided by the DTLR "Domestic heating & hot water guide" to the building regs. 2001 - part L1 and the references:

1) GIL 59, 2000: Central heating system specification (CheSS) and

2) GPG 302, 2001: Controls for domestic central heating system and hot water. BRECSU.

A WRC approved filling loop is supplied with the boiler to enable correct filling of the system. In the case of an existing installation, it is **ESSENTIAL** that the system is thoroughly flushed prior to installing the new boiler, using a proprietary product such as Fenox or Sentinel. Contact the product manufacturers for specific details.

Domestic hot water system design

All domestic hot water circuits, connections, fittings must be in accordance with the relevant standards and water supply regulations.

For GB: Guidance G17 to G24 and recommendation R17 to R24 of the Water Regulations Guide.

For IE: The current edition of I.S.813 "Domestic Gas Installations".

Copper tubing or plastic Hep₂O may be used for the domestic hot water system. Unnecessary pressure losses should be avoided. The domestic hot water supply pressure must be between 1 and 6 bar. If the pressure exceeds 6 bar, a pressure reducing valve must be fitted. In known hard water areas, it is recommended that a suitable scale reducing device is fitted to the cold water supply to the boiler.

Boiler connections

- A Heating flow
- B Hot water outlet
- C Gas connection
- D Cold water mains inlet
- E Heating return
- F Safety valve discharge connection

Heating system connections

- Pipe diameter 22 mm.

Hot water system connections

- Pipe diameter 15 mm.

Gas connection

- Pipe diameter 22 mm.

Safety valve discharge connection

- Pipe diameter 22 mm.

Note: White colored washers must be used for the hot water system connections

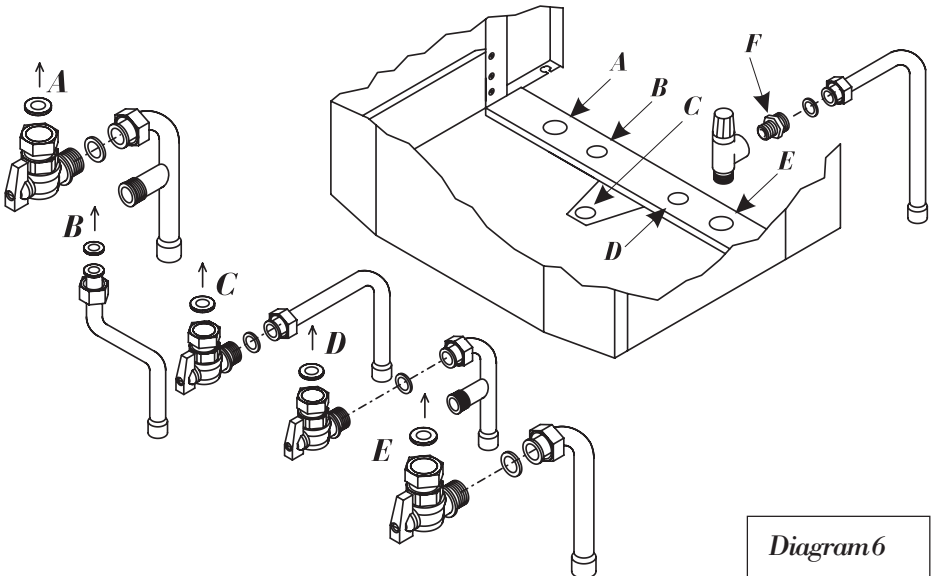
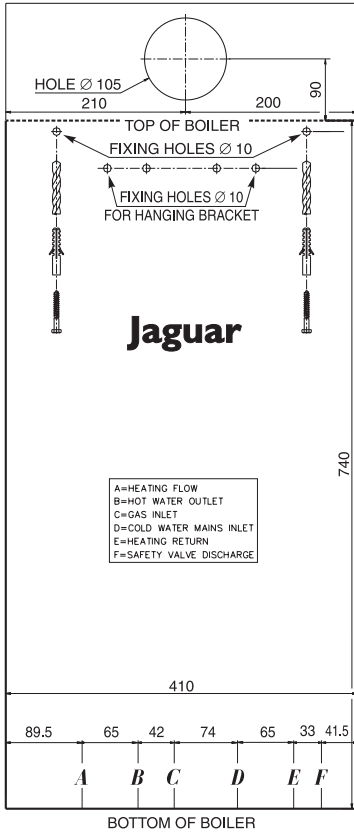

Diagram 6

BOILER TEMPLATE

Jaguar 23



Jaguar 28

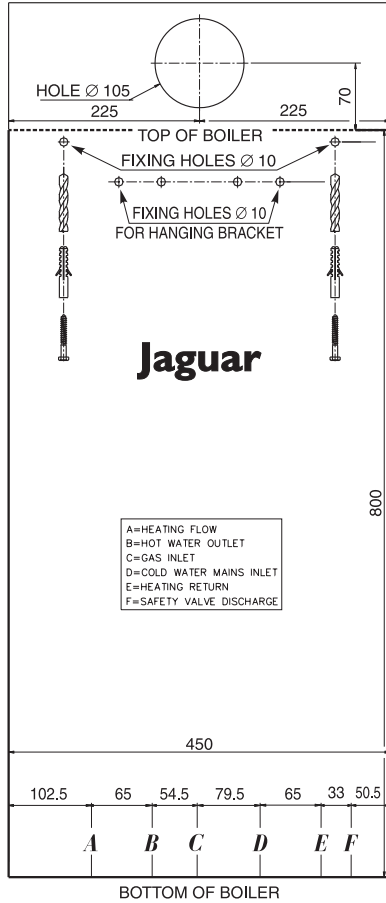

Boiler connections

- A** Heating flow
- B** Hot water outlet
- C** Gas connection
- D** Cold water mains inlet
- E** Heating return
- F** Safety valve discharge connection

Diagram 7

BOILER INSTALLATION

Statutory requirements

The appliance is suitable only for installation in GB and IE and should be installed in accordance with the rules in force.

In GB the installation of the boiler must be carried out by a competent person as described in the following regulations:

The manufacturer's instructions supplied.

The Gas Safety (Installation and Use) Regulations.

The appropriate Buildings Regulations either The Building Regulations, The Building Regulations (Scotland), The Building Regulations (Northern Ireland).

The Water Fittings Regulations or Water byelaws in Scotland.

The Health and Safety at Work Act, Control of Substances Hazardous to Health (COSHH). The Current I.E.E. Wiring Regulations.

Where no specific instructions are given, reference should be made to the relevant British Standard Code of Practice.

In IE, the installation must be carried out by a competent person and installed in accordance with the current edition of I.S.813 "Domestic Gas Installations", the current Building Regulations and reference should be made to the current ETCI rules for Electrical Installation.

In GB the following Codes of Practice apply:

BS4814, BS6798, BS5440 Part 1 and 2, BS5546 Part 1, BS5449, BS6891, BS6700, BS7074 Part 1 and 2, BS7593, BS7671.

In IE: I.S.813, BS5546, BS5449, BS7074, BS7593.

Manufacturer's instructions must not be taken as overriding statutory requirements.

Sheet metal parts

WARNING. When installing or servicing this boiler, care should be taken when handling the edges of sheet metal parts to avoid the possibility of personal injury.

Installing the boiler

Prior to starting work, the system must be thoroughly flushed using a proprietary cleanser such as **Sentinel X300** to eliminate any foreign matter and contamination e.g. metal filings, solder particles, oil, grease etc.

Note. Solvent products could cause damage to the system.

To install the boiler, proceed as follows:

- Allowing sufficient clearances for servicing/repair, place the template on the wall (see diagram 7).

Note: The boiler can be installed only on the closed wall.

- Determine the position of the flue hole and drill hole for flue, preferably using a 120 mm core drill.
- Drill two **10 mm** holes for the wallplugs supplied.
- Screw fixing screws supplied into wallplugs, leave proud by approx. 10 mm.
- The fixings supplied may not be suitable for some walls. Be sure to use a type that will support the total weight of the appliance.

Note: Boiler fixing holes are keyhole type slots at the top of the boiler to allow easy hanging of boiler.

- Remove template.
- It is recommended to fit the safety discharge pipe before hanging the boiler on the wall.
- Hang the boiler on the screws and tighten screws.

Note: As a option the hanging bracket can be used. Two screws are sufficient for fixing of the hanging bracket. Hanging bracket fixing screws have to be fully tight before the boiler is hung on.

Pipework connections

- Remove plastic caps from boiler connections.
- Connect the central heating pipework connections and isolating cocks as shown on diagram 6.
- Connect the domestic cold water inlet connection and isolating cock.
- Connect the hot water outlet connection.
- Connect the gas connection and isolating cock.

The whole of the gas installation, including the meter, should be inspected, tested for soundness and purged in accordance with the current issue of BS6891 and in IE the current edition of I.S.813 "Domestic Gas Installations".

- Finally, connect the filling loop between the cold water inlet pipe and the heating flow pipe.

HORIZONTAL FLUE INSTALLATION

- A** Air inlet pipe
- B** Terminal
- C** Seal and clamp
- D** Elbow
- E** Gasket
- F** Screws
- G** External rubber sealing collar
- I** Internal plastic collar
- J** 'O' rings
- K** Spacer (Jaguar 23 only)

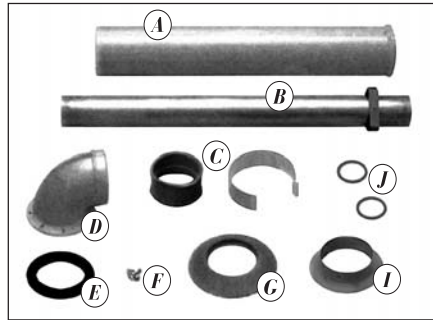

Diagram 8

- **Fit gasket (E) onto underside of flue elbow (D).**
- Carefully insert 'O' ring (J) into upper and lower parts of inner elbow.
- Place spacer (K) (supplied with boiler) onto top of boiler Jaguar 23 only (see diagram 9).
- Fit elbow onto spacer ensuring elbow inner connection locates correctly onto fan outlet.
- Fit external rubber sealing collar (G) onto air inlet pipe (A).
- Fit flue through hole in wall and pull up so that external collar (G) is flush against outside wall.
- Fit seal and clamp (C) to flue and assemble into elbow (D) making sure that both inner and outer pipes are sealed properly.

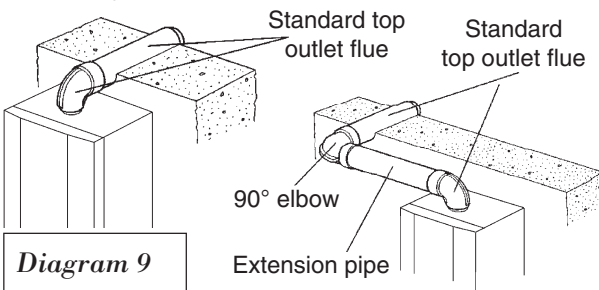
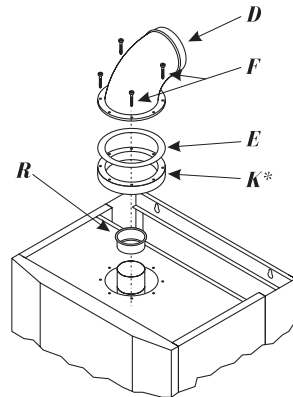

Diagram 9



K* - Jaguar 23 only

Note: Maximum horizontal length with no bends is 4 m (Jaguar 23) or 3 m (Jaguar 28). For horizontal flue lengths up to 1 m the restrictor must be left in the fan outlet, see diagram 9. For horizontal flue lengths between 1 and 4 m (Jaguar 23) or 3 m (Jaguar 28), remove the restrictor (**R**).

- Tighten up clamp using screws provided.

Note: Should it be necessary to cut the flue, always cut equal amounts from both inner and outer pipes.

Always cut the end furthest from the terminal.

For each 90° flue bend fitted, reduce overall flue length by 1 m.

For each 45° flue bend fitted, reduce overall flue length by 1/2 m.

Horizontal flue kit	1/08/710
Flue extension kit	1/08/711
90° concentric bend kit	1/08/712
45° concentric bend kit	1/08/713

TELESCOPIC HORIZONTAL FLUE INSTALLATION

Telescopic Top Outlet Flue Pack 1/08/705

Flue Position and Length

Determine flue application, length and terminal position before starting.

Refer to diagram 9a.

To make a neat finish to the flue outlet a flue collar is included.

Flue Assembly

Extend the telescopic flue to the required length, making sure that the minimum overlap is no less than 15 mm, and that the flue terminal projects 20 mm beyond wall face.

Carefully drill through air duct pilot hole and secure with self tapping screw.

The telescopic flue can only be used on its own without flue elbows or extensions.

If the boiler is not to be fitted for some time cover the hole in wall.

Top Outlet Side or Rear Flue Fixing

Make good the area around the flue inside and outside after installation of the boiler.

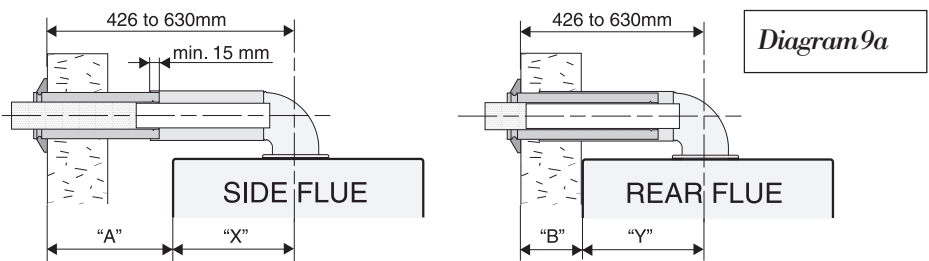

	FLUE OUTLET	DISTANCE FROM FLUE AXIS TO BOILER CASING "X"	DISTANCE FROM FLUE AXIS TO BOILER MOUNTING FACE "Y"	MINIMUM - MAXIMUM DISTANCE FROM	
				BOILER CASING TO EXTERNAL WALL FACE "A"	BOILER MOUNTING FACE TO EXTERNAL WALL FACE "B"
JAGUAR 23	REAR	-	162	-	264 to 468
	RIGHT SIDE	200	-	226 to 430	-
	LEFT SIDE	210	-	216 to 420	-
JAGUAR 28	REAR	-	180	-	246 to 450
	SIDE	225	-	201 to 405	-

Flue Positioning

Push the flue assembly into and through the hole such that it is within the wall, and does not stick out into the room. Do not push the flue assembly too far into the hole as it has to be pulled back into the boiler and secured.

VERTICAL FLUE INSTALLATION

- Fit gasket (**E**) onto underside of vertical adaptor (**O**) – see diagram 10.
- Carefully insert 'O' ring (**J**) into vertical adaptor inner spigot.
- Place spacer (**K**) on the top of boiler (Jaguar 23 only).
- Fit vertical adaptor (**O**) onto spacer (**K**) ensuring adaptor inner connection locates correctly onto fan outlet.
- Fit extension pipes (**M**) as required.
- For pitch roof installation, fit pitch roof flashing (part no. 1/08/726).
- Fit flue terminal (**L**) onto roof ensuring flashing makes a watertight joint.

Note: Maximum vertical height with no bends is 9 m.
Should it be necessary to cut the flue, always cut equal amounts from both inner and outer pipes.
Connect condensate trap (supplied) to vertical flue adaptor when flue length exceeds 3 m.
Connect 15 mm plastic pipe (not supplied) to a suitable drain.
For vertical flue lengths up to 4 m the restrictor must be left in the fan outlet, see diagram 9.
For vertical flue lengths between 4 and 9 m, remove the restrictor (**R**).

For each 90° flue bend fitted, reduce overall flue height by 1 m.
For each 45° flue bend fitted, reduce overall flue height by 1/2 m.

Roof terminal (black)
Pitched roof flashing
Flue extension pipe
90° concentric bend kit
45° concentric bend kit
flue outlet adaptor c/w condensate trap
400 – 500 mm sliding concentric flue pipe
fixing brackets (Pack 3)

1/08/725
1/08/726
1/08/721
1/08/723
1/08/724
1/08/720
1/08/722
1/08/727

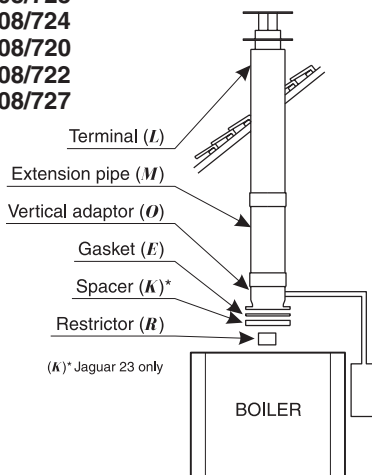
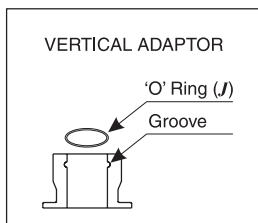
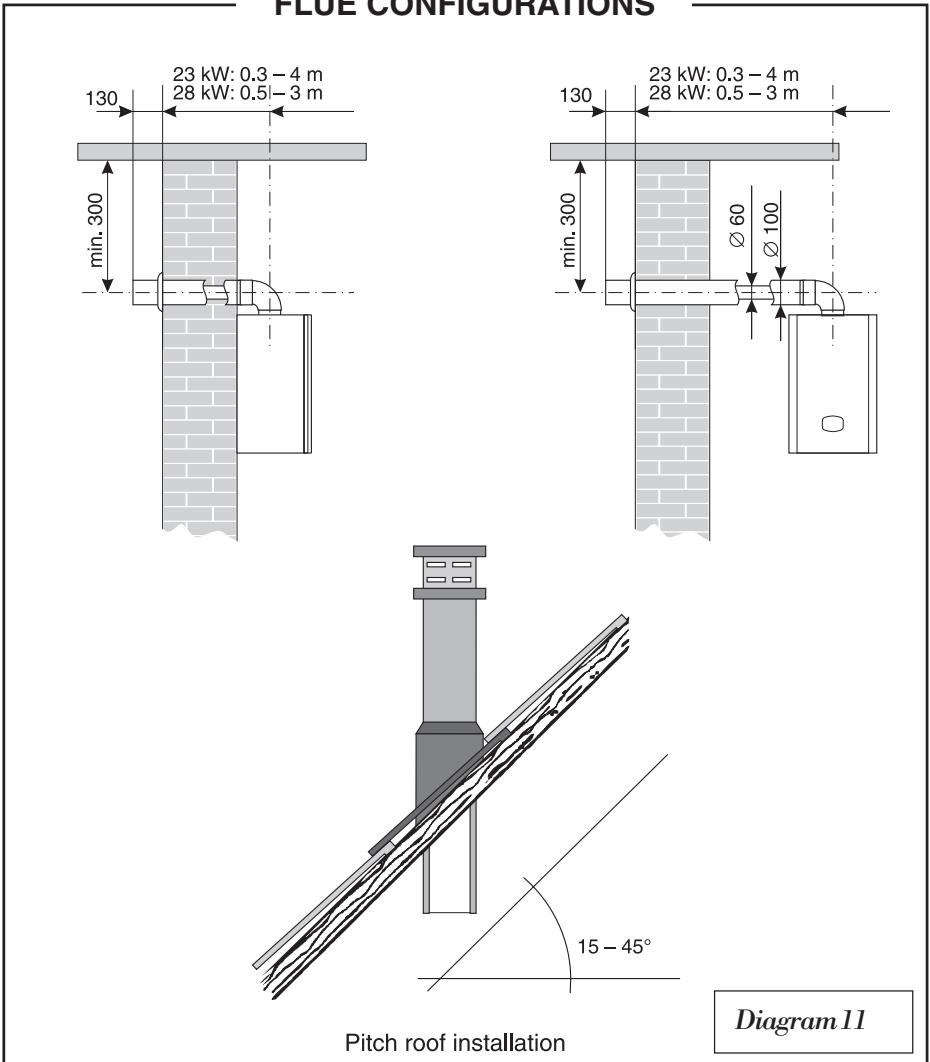

Diagram 10

FLUE CONFIGURATIONS



ELECTRICAL CONNECTION

Warning: This boiler must be earthed.

All system components must be of an approved type.

Connection of the whole electrical system and any heating system controls to the electrical supply must be through a common isolator.

Isolation should preferably be by a double pole switched fuse spur box having a minimum contact separation of 3 mm on each pole. The fused spur box should be readily accessible and preferably adjacent to the boiler. It should be identified as to its use.

A fused three pin plug and shuttered socket outlet may be used instead of the fused spur box, provided that:

- a) They are not used in a room containing a bath or shower.
- b) Both the plug and socket comply with the current issue of BS1363.

The mains electrical supply must be maintained at all times in order to provide domestic hot water and frost protection.

It is recommended that a room thermostat is fitted.

Thermostatic radiator valves may be installed in addition to the room thermostat.

Note: For further information, see The Building Regulations 1991 - Conservation of fuel and power - 1995 edition - Appendix G, table 4b.

DO NOT INTERRUPT THE MAINS SUPPLY TO THE BOILER WITH A TIME SWITCH OR PROGRAMMER.

The **Jaguar** is delivered with 1metre mains supply lead ready connected.

The electrical supply cable is the original spare part and must be replaced only by original supply cable for JAGUAR boiler.

Warning: If the supply cord is damaged, it must be replaced by the Installer/Service provider to avoid a hazard.

External controls

The boiler will work for heating **AS DELIVERED** without a room thermostat fitted provided the two wires on the integral external controls connection **REMAIN LINKED TOGETHER** (as supplied). If a room thermostat is required, it must be connected as shown below and the link must be removed.

ANY ROOM THERMOSTAT USED MUST BE OF THE VOLTAGE FREE TYPE.

WARNING: ON NO ACCOUNT MUST ANY ELECTRICAL VOLTAGE BE APPLIED TO EITHER OF THE TERMINALS OF THE EXTERNAL CONTROLS CONNECTION

WARNING: This boiler must be wired in accordance with these instructions. Any fault arising from incorrect wiring cannot be put right under the terms of the guarantee.

Testing - Electrical

Checks to ensure electrical safety must be carried out by a competent person.

After installation of the system, preliminary electrical system checks as below should be carried out.

1. Test insulation resistance to earth.
2. Test earth continuity and short circuit of all cables.
3. Test the polarity of the mains.

The installer is requested to advise and give guidance to the user of the controls scheme used with the boiler.

Note: For further information, see the building regulations 1991 - Conservation of Fuel and Power - 1995 edition - appendix G, Table 4b.

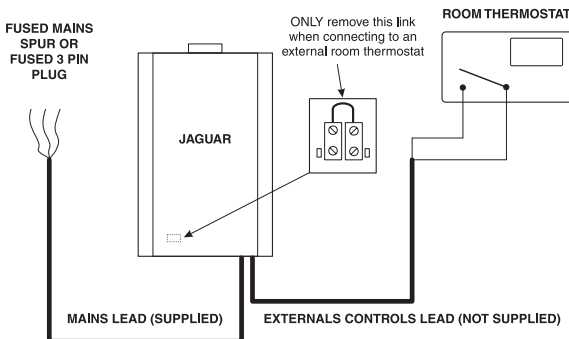

Diagram 12

COMMISSIONING

The commissioning and first firing of the boiler must only be carried out by a qualified competent person.

To gain access to the inside of the boiler undo screw securing front panel at the boiler bottom, remove front panel by pulling forwards, lifting it up and off. Note – upper edge of front casing is fixed to the boiler by means of 2 pins.

Filling the system

- Check that the gas meter tap is closed.
- Connect boiler to electrical supply.
- Place switch (1) diagram 1 to position 'I' FO is displayed and the pump runs for about one minute.
- Place the slide switch on TIMECLOCK to 'RUN' position. Use the 'On/Off' button to set the boiler 'On' For programming see chapter 'TIMECLOCK INSTRUCTIONS'
- Press the BAR/Mode button, see diagram 1. Value of system pressure (0.0) is displayed and LED (2) – see diagram 1 – lights.

Note: The pressure is displayed for about 25 sec. After this time the display comes back to the standby mode. The pressure can be displayed after pressing Bar/Mode push button again.

- Open isolating valves (**A**, **E** and **D**) see diagram 6.
- Undo, but not remove, cap on automatic air vent on the top of the pump.
- Fill system by opening system filling loop until a pressure of between 1 and 2 bar is shown on the display.
- Bleed each radiator until a continuous jet of water is obtained.
- Do not retighten automatic air vent cap.
- Open various hot water taps to bleed hot water circuit.
- Make sure that pressure is between 1 and 2 bar. Re-pressure as necessary.

Important: When venting air from boiler, do not touch the schrader valve on the expansion vessel, it is NOT a vent.

Starting the boiler

Before starting the boiler check that:

- The gas meter tap is open. - The boiler gas service cock is open.
- The water isolating cocks are open. - The boiler is connected to the electrical supply.

First starting up

- Place main switch (1) diagram 1 to position 'I'
- Set maximum heating water temperature (85°C), as described in '**Users Instructions**' and check that any external controls, if fitted, are calling for heat.
- Allow the temperature to rise to the maximum value, with all radiator valves open. Air contained in the water of central heating system will be automatically released through the automatic air vent. Air trapped at the highest point of the system must be released by bleeding the radiators.

On reaching maximum temperature, the boiler should be turned off and the system drained as rapidly as possible whilst still hot.

- Refill system to a pressure at least of 1 bar and vent as before.
- Restart boiler and operate until a maximum temperature is reached. Shut down boiler and vent air from heating system. If necessary, top up heating system and make sure that a pressure at least of 1 bar is indicated on the display when system is COLD.

Gas installation

It is recommended that any air is purged from the supply at the gas inlet test point on the gas valve, see diagram 13.

1 - Inlet test point 2 - Outlet test point

Gas pressures

- Shut down boiler.
- Undo screw on gas inlet test point '1' on gas valve, see diagram 13.
- Connect a suitable pressure gauge.
- Start boiler as described in '**Users Instructions**'.
- Check that there is a constant pressure of 20 mbar for Natural gas (37 mbar for Propane). If the pressure is insufficient, it is necessary to check the gas supply/pipe-work and correct any fault.
- Shut down boiler.
- Remove pressure gauge, tighten up carefully test point screw and check for gas soundness.

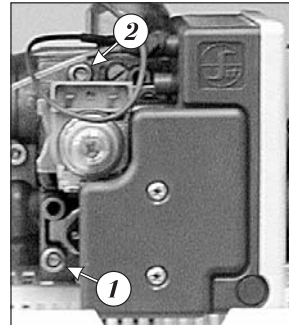

Diagram 13

Check the burner gas rate required, ten minutes after lighting. Refer to Data Label. Should any doubt about the gas rate it should be checked at the metre refer to Technical Data pages 15 and 16.

Setting the central heating output

The central heating output must be set in accordance with the system requirements.

Setting procedure as follows:

- < Push and hold the Bar/Mode button for at least 8 sec. The display will switch to service mode, the symbol **n-** will be displayed, see diagram 14.
- < Set the desired output value from **n1** to **n9** by means of buttons (7) and (8) according to the following table:

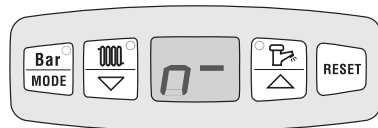

Diagram 14

HEAT OUTPUT

Jaguar 23

Jaguar 28

	kW (Btu/hr)		kW (Btu/hr)
n1	9.3 (31 732)	11.0 (37 532)
n2	11.0 (37 532)	13.0 (44 356)
n3	12.0 (40 944)	16.0 (54 592)
n4	14.0 (47 768)	18.0 (61 416)
n5	16.0 (54 592)	20.0 (68 828)
n6	18.0 (61 416)	22.0 (75 064)
n7	20.0 (68 828)	24.0 (81 888)
n8	22.5 (76 770)	26.0 (88 712)
n9	23.0 (79 152)	27.6 (94 171)
n-	23.0 (79 152)	27.6 (94 171) .. max. output

- < Press Bar/Mode button to save and return to main menu.

Safety devices

Air flow rate safety device

If an obstruction, even partial, of the flue occurs, the built in safety system of the boiler will turn the boiler OFF. The boiler will be ready to operate when the fault has been cleared.

In case of power supply failure

The boiler no longer operates. As soon as power is restored, the boiler will be automatically restarted. If the boiler does not restart, the overheat device may need resetting.

Overheat safety

In the event of overheating, the overheat safety device causes safety shutdown of the boiler. The digital display will show error code F1, see diagram 15. To reset, let the boiler cool down, press the reset button on the safety device (a) and (c - only Jaguar 23), see diagram 24 and reset boiler controls by means of the reset button (6), see diagram 15.

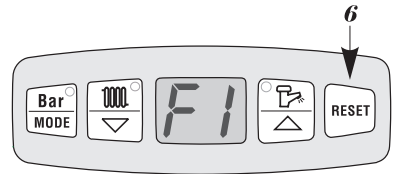

Diagram 15

Note: wire connections to overheat thermostat are mains voltage.

Important notice

A central heating system cannot operate satisfactorily unless it is properly filled with water and unless the air initially contained in the pipework system has been properly bled off. If these conditions are not satisfied, air noise will occur within the system and the boiler may fail to operate.

To reset the boiler (other than for overheating) use the reset button on the fascia, see diagram 15.

The **Jaguar** boiler has a built-in frost protection device that protects the boiler during freezing conditions. This device works irrespective of any room thermostat setting and only protects the boiler.

Should the temperature within the central heating circuit of the boiler fall below 10 °C, the pump will switch on providing the electrical supply has been left connected. If the temperature falls below 8 °C, then the burner will operate until the water temperature increases to 25 °C. Should the electrical supply have been disconnected and the boiler/system has frozen, the boiler will not start up until the boiler/system has been cleared.

Adjust the boiler temperature control and any system controls to their required settings. In addition it is necessary to complete the "Benchmark" logbook.

For IE, it is necessary to complete a "Declaration of Conformity" to indicate compliance to I.S.813. An example of this is given in the current edition of I.S.813.

INSTRUCT THE USER

Instruct and demonstrate the lighting procedure and advise the user on the safe and efficient operation of the boiler.

Instruct on and demonstrate the operation of any heating system controls.

Advise the user on the use and maintenance of any scale reducer and pass on any relevant instructional documents.

Advise that to ensure the continued efficient and safe operation of the boiler it is recommended that it is checked and serviced at regular intervals. The frequency of servicing will depend upon the installation conditions and usage, but in general, once a year should be enough.

Draw attention, if applicable, to the current issue of the Gas Safety (Installation and Use) Regulations, Section 35, which imposes a duty of care on all persons who let out any property containing a gas appliance in the UK.

The user shall not interfere with or adjust sealed components.

It is the Law that any servicing is carried out by a competent person.

Advise the user of the precautions necessary to prevent damage to the system, boiler and the building, in the event of the heating system being out of use during frost or freezing conditions.

Advise the user that the permanent mains electrical supply **SHOULD NOT** be switched off, as the built in frost protection and pump saver program would not be operable.

Reminder, leave these instructions and the 'Benchmark' logbook with the user.

SERVICING INSTRUCTIONS

To ensure the continued efficient and safe operation of the boiler, it is recommended that it is checked and serviced at regular intervals. The frequency of servicing will depend upon the installation conditions and usage but, in general, once a year should be enough.

REMEMBER, when replacing a part on this appliance, use only spare parts that you can be assured conform to the safety and performance specification that we require. Do not use reconditioned or copy parts that have not been clearly authorised by Hepworth Heating.

It is the law that any servicing is carried out by a competent person.

ROUTINE CLEANING AND INSPECTION

- Operate boiler and check for any faults that need to be put right.
- Isolate boiler from the gas and electrical supplies.
- On completion check all gas carrying parts for soundness with leak detection fluid.

Products of combustion check

To obtain a products of combustion reading, unscrew the left hand sampling point cap on the flue elbow, located on top of boiler. Connect the analyser tube onto sampling point. Refer to the combustion product values on **pages 14 and 15 Technical Data**. Switch on the electrical supply and gas supply, then operate the boiler.

On completion of the test switch off the electrical supply and the gas supply, remove analyser tube and replace sampling point cap.

Remove boiler casing as follows:

Outer casing

- Undo screw securing the casing underneath boiler and remove outer casing by pulling forwards, lifting it up and off.

Sealed chamber, see diagram 16.

- Unclip two clips holding sealed chamber cover to boiler, unscrew two screws in middle of the cover (only for Jaguar 28) and lift it forwards and off.

Side cover left hand side

- Pull down the control panel, disconnect the earth lead
Undo 3 screws securing side cover two at the front one underneath and remove side cover by pulling to side, forwards and off.

Side cover right hand side

- Undo 3 screws securing side cover two at the front one underneath and remove side cover by pulling to side, forwards and off.

Cleaning the burner (Jaguar 23), see diagram 17a.

- Unscrew and remove 6 screws securing combustion chamber cover and remove cover.
- Disconnect flame sense electrode (1) and ignition lead at gas valve module.
- Disconnect ignition earth lead (2).
- Undo nuts (A) securing gas supply pipe between burner and gas valve and remove pipe

Note: The washer between the burner and burner gas supply must be kept to use on reassembly.

- Unscrew 2 nuts (B) securing burner to base of sealed chamber.
- Undo screws (C) holding manifold to burner. Pull manifold up and forward of chamber.
- Remove burner out of boiler.
- Examine and clean burner as necessary.

Note: DO NOT use a wire or sharp instrument on the holes.

PRODUCTS
SAMPLING
POINT

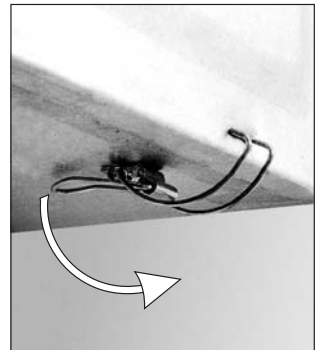
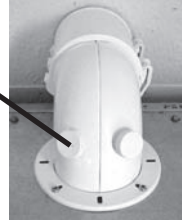

Diagram 16

Cleaning the burner (Jaguar 28), see diagram 17b.

- Unscrew and remove 6 screws securing combustion chamber cover and remove cover.
- Disconnect flame sense electrode at burner.
- Disconnect ignition lead at gas valve module.
- Disconnect ignition earth lead.
- Undo nuts (A) securing gas supply pipe between burner and gas valve and remove pipe.

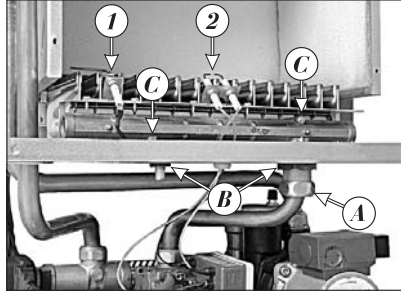

Diagram 17a

- Note:** The washer between the burner and burner gas supply must be kept to use on reassembly.
- Unscrew 2 screws (B) securing burner to base of sealed chamber.
 - Pull main burner up and forward out of boiler.
 - Examine and clean burner as necessary.
- Note:** DO NOT use a wire or sharp instrument on the holes.

Heat exchanger, see diagram 18.

- Locate the heat exchanger inside the sealed chamber.
- Gain access to heat exchanger by removing fan, refer to replace fan in replacement parts. Unclip the strain relief grommet (B). Remove the flue hood secured with two screws (A) at the rear.
- Examine heat exchanger for any blockages or build up of deposits.
- Clean heat exchanger with soft brush or vacuum cleaner.

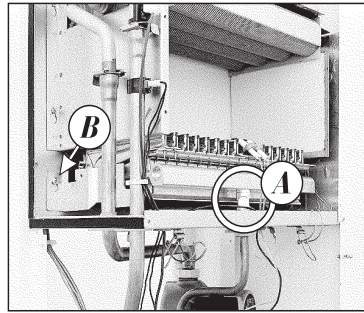

Diagram 17b

Reassembly of parts removed for servicing

All parts are replaced in reverse order to removal.

Flue system

- Check externally to make sure that flue is not blocked.
- Inspect flue system to make sure that all fittings are secure.

Operation of fan

- Switch on electrical supply and turn on gas.
- Remove sealed chamber cover.
- Light burner by operating external controls (if fitted) to call for heat.
- Check that fan operates when burner lights and stops when it goes out.

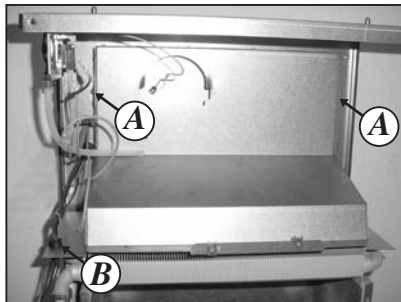

Diagram 18

REPLACEMENT OF PARTS

IMPORTANT INFORMATION

WARNING: Before commencing the replacement of any component, isolate appliance from electrical supply and turn off gas at service cock.

Replacement of parts must be carried out by a competent person.

When replacing components it may be necessary to renew sealing washers, gaskets and 'O' rings. If new ones are supplied with replacement components they must be used.

All parts are replaced in reverse order to removal.

If any gas-carrying components are disturbed, removed or replaced it will be necessary on completion to check for gas soundness with leak detection fluid.

To drain the domestic hot water or boiler refer to diagram 19.

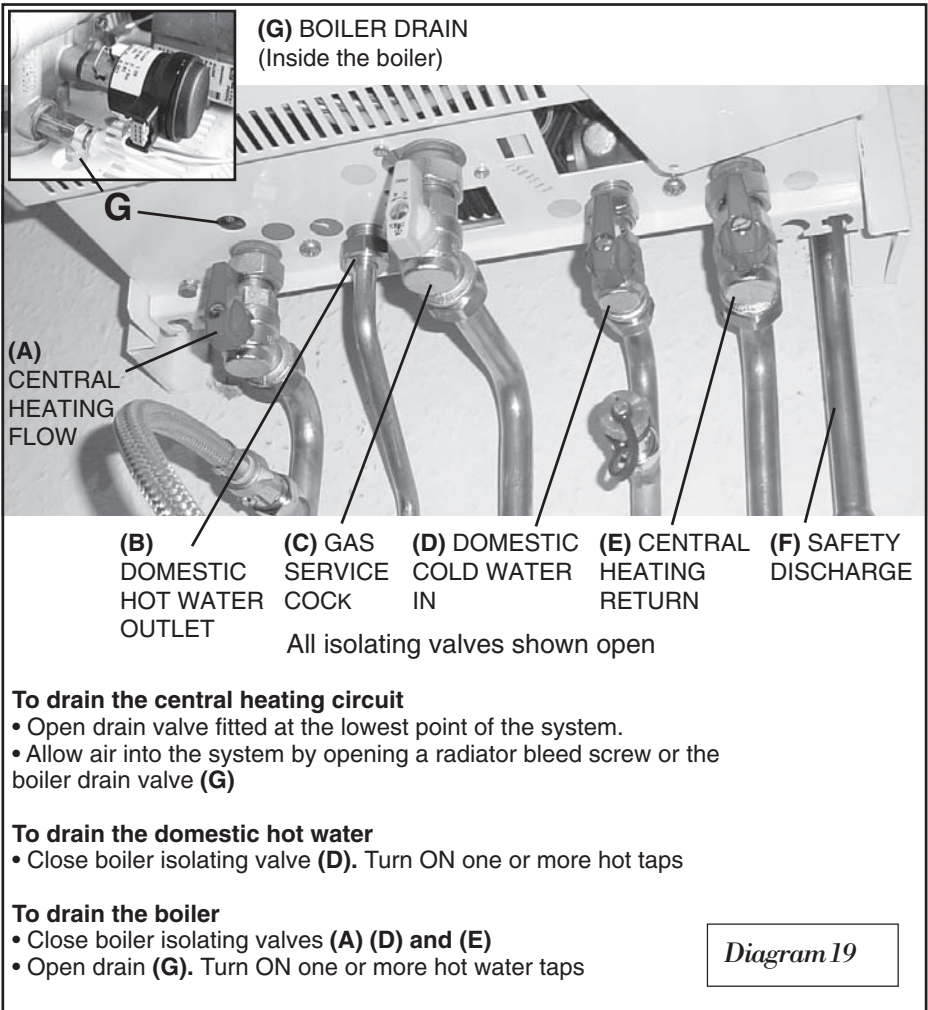

To gain access to the boiler components, proceed as follows:

- Isolate boiler from electrical supply.
- Remove outer case, if necessary sealed chamber cover, combustion chamber cover and side covers, see '**Routine cleaning and inspection**'
- Gently squeeze metal clip securing the control panel box, lift it up and hinge down.

To replace fan, see diagram 20.

- Disconnect power supply and earth leads to fan.
- Disconnect air pressure tube at fan
- Supporting fan, unscrew and remove screw (A) securing fan.
- Gently ease fan by pushing down and out of boiler.
- Fit replacement fan, making sure that mounting plate engages correctly onto flue hood

Important: Ensure that fan outlet is correctly fitted into flue elbow at top of boiler.

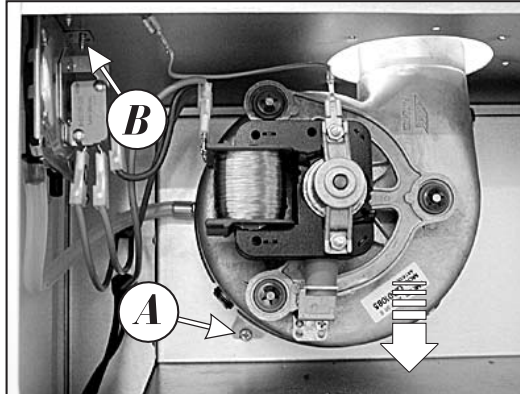

To replace air pressure switch, see diagram 20.

- Locate air pressure switch in upper left hand corner of sealed chamber.
- Pull off clear plastic tube from base of switch.
- Remove electrical connections from the switch.

Important: Mark the connectors – it is necessary they have to be connected in the same position.

- Unscrew and remove two screws (B) securing switch to upper panel and remove switch.
- Fit replacement switch.
- Fit electrical connections to replacement switch.
- Refit clear plastic tube to switch connection L.

Note: If the fan will not run after switch on the boiler, the order of connections is probably incorrect.

To replace gas valve module, see diagram 21.

- Locate gas valve module attached to side of gas valve.
- Unscrew screws (a) and (b) securing cover onto gas valve module.
- Remove cover and disconnect multi-plug from module.
- Disconnect ignition and flame sense leads from module and withdraw module from gas valve.
- Fit replacement module.
- Reconnect ignition and flame sense leads, the connections are uniquely sized to ensure correct replacement.
- Refit cover ensuring all sealing grommets are correctly located in module body.

Diagram 20

To replace gas valve, see diagram 21.

- Ensure that gas supply is turned off at gas cock.
- Unscrew screw (a) and remove gas valve module.
- Undo nuts securing gas supply pipe between burner and gas valve and remove pipe, taking care not to lose sealing washers.
- Remove gas inlet connection to boiler.
- Unscrew 2 screws securing gas valve to boiler bottom.
- Remove gas valve by lifting upwards and out of boiler.
- Fit replacement gas valve.
- Check for gas-tightness.
- After assembly test for gas soundness and purge in accordance with the current issue of BS6891 or in IE, the current edition of I.S.813 "Domestic Gas Installations".

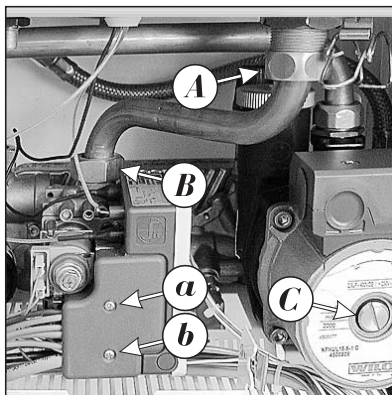

Diagram 21

To replace burner

- Remove burner as described in 'Cleaning the burner'.
- Fit replacement burner.
- Check if the injectors are correct.

To replace pump, see diagram 22.

Drain down heating circuit only, refer to diagram 19.

Note: It is not necessary to drain down entire heating circuit to carry out this work.

Simplification: for simpler work remove gas valve module and right side cover.

- Disconnect pump cable.
- Remove 2 clips fixing pump
- Unscrew 2 screws securing the pump to boiler bottom.
- Lift up the pipe and remove pump by lifting forward and out of boiler.
- Fit replacement pump.
- Open isolating valves on flow and return connections,
- Refill, vent and pressurise boiler. Check for leaks.

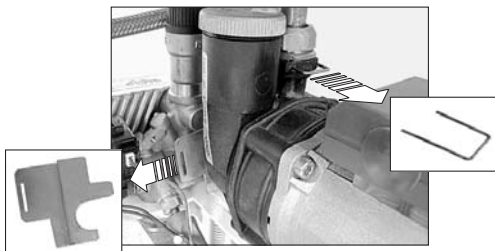

Diagram 22

To replace safety valve, see diagram 23.

- Drain down heating circuit of boiler only, refer to diagram 19.

Simplification: for simpler work remove gas valve module and pump as described previously.

- Remove expansion vessel hose (D) from hydraulic block.
- Remove draining pipe (C) from safety valve and unscrew safety valve.
- Remove adaptor (B) from safety valve.
- Fit adaptor (B) to replacement safety valve (A).
- Fit replacement safety valve (A).

Important: Seal the safety valve thread using jointing compound.

To replace domestic heat exchanger

- Drain down heating circuit of boiler only, refer to diagram 19.
- Remove gas valve.
- Unclip pump and pull forwards.
- Disconnect expansion flexible hose at connection to vessel fixing.
- Remove fixing screws and plate exchanger over hydraulic block.
- Fit replacement heat exchanger, ensuring seals are correctly positioned in hydraulic block.
- Open isolating valves on flow and return connections, refill, vent and pressurise boiler. Check for leaks.
- Open cold water isolating valve. Check for leaks.

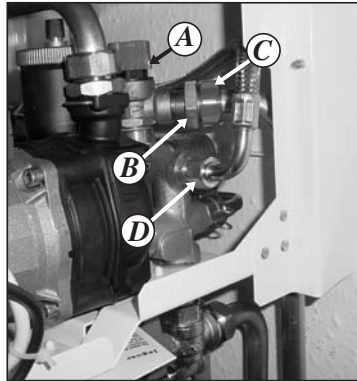

Diagram 23

To replace overheat thermostats, see diagram 24.

Important: Isolate boiler from electrical supply before this operation – connections to overheat thermostats are mains voltage.

- Locate overheat thermostat (a) or (c - only for Jaguar 23) to left hand side of sealed chamber, see diagram 21.
- Unclip thermostat from pipe.
- Pull off electrical connections from thermostat.
- Fit replacement thermostat.

Note: No heat sink compound is required. The polarity of the connections is not important.

To replace heating water thermistor, see diagram 24.

- Locate thermistor (b) clipped onto flow pipe to left hand side of sealed chamber below overheat thermostat, see diagram 21.
- Unclip thermistor from pipe.
- Pull off electrical connections from thermistor.
- Fit replacement thermistor.

Note: No heat sink compound is required. The polarity of the connections is not important.

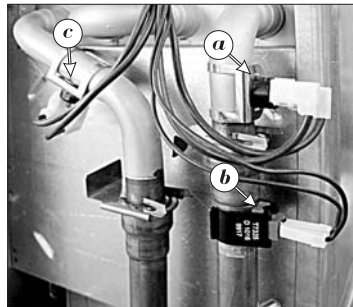

Diagram 24

To replace hot water thermistor

- Pull off electrical connections from thermistor and unscrew thermistor from left part of hydraulic block.
- Remove gas valve module as described previously.
- Fit replacement thermistor.

Note: The polarity of the connections is not important.

To replace printed circuit board (PCB)

Important: Isolate boiler from electrical supply before this operation.

- Gently squeeze metal clip securing the control panel box, lift it up and hinge down.
- From behind control panel box, unscrew and remove 4 screws securing PCB cover to panel.
- Pull off electrical plugs from PCB.
- Remove 4 screws securing PCB to panel and lift out PCB.
- Fit replacement PCB.

Diagram 25

To replace display and control panel board, see diagram 25.

Important: Isolate boiler from electrical supply before this operation.

- Remove PCB cover as described in 'To replace PCB'.
- Pull off electrical plug of display (A) from PCB, see diagram 22.
- Remove 4 screws securing PCB to panel and lift out PCB.
- Remove 4 screws securing display and control panel board to panel and gently lift it out.
- Fit replacement display and control panel board.

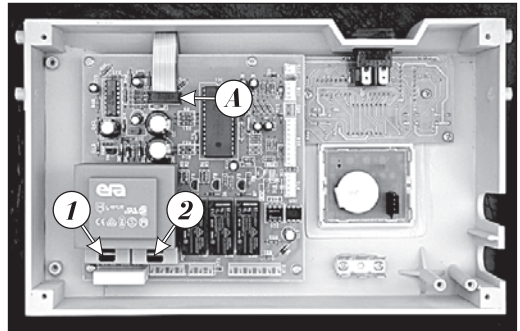

To replace timeclock

- Remove PCB cover as described in 'To replace PCB'.
- Disconnect clock electrical connections from PCB. Unclench and remove plastic clips securing timeclock to lower front panel.
- Remove control panel sticker and timeclock from panel.
- Fit replacement timeclock.
- Stick new control panel sticker.

To replace pressure sensor, see diagram 26.

- Drain boiler only, refer to diagram 19.
- Unclip pressure gauge clip and pull it out.
- Disconnect pressure gauge cable.
- Fit replacement pressure gauge.

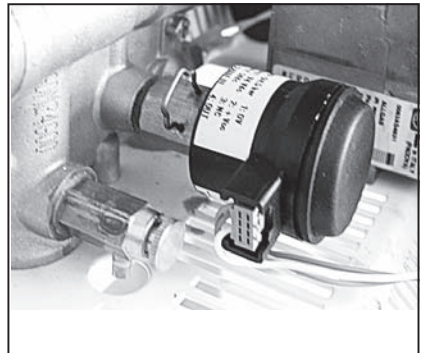

Diagram 26

To replace heat exchanger

- Drain down heating circuit of boiler only, **refer to diagram 19**.
- Remove sealed and combustion chamber covers and side cases as described previously.
- Remove overheating thermostats from heat exchanger pipes.
- Pull off spring clips securing heat exchanger pipes to heat exchanger.
- Manoeuvre heat exchanger pipes down to disengage from heat exchanger.
- Gain access to heat exchanger by removing fan and flue hood.
- Remove heat exchanger by sliding forward and out of boiler.
- Fit replacement heat exchanger.
- Open isolating valves on flow and return connections, refill, vent and pressurise boiler. Check for leaks.

To replace expansion vessel, see diagram 27.

Renewal of the expansion vessel requires the boiler to be removed from the wall. As an alternative, a separate expansion vessel of the same specification may be connected as close as possible to the boiler, leaving the original in position, refer to the installation instructions.

- **IMPORTANT:** With regards to the manual handling operations, 1992 regulations, the following operation exceeds the recommended weight for one man lift.
 - Isolate the appliance from electrical supply and turn off gas at service cock.
 - It will be necessary on completion to check for gas soundness with leak detection fluid.
 - Drain down the boiler only, **refer to diagram 19**.
 - Disconnect the flue system.
 - Disconnect the boiler pipes at the fixing jig.
 - Disconnect the pressure relief valve discharge pipe.
 - Disconnect the mains cable and any external controls cables.
 - Lift up to remove the boiler from the wall.
 - From the rear of the boiler.
 - Undo pipe coupling on expansion vessel.
 - Lift to remove expansion vessel.
- Note: Check that expansion vessel pressure is correct, **see 'Section 14 and 15 Technical Data'**.
- Open isolating valves on flow and return connections, refill, vent and pressurise boiler. Check for leaks.

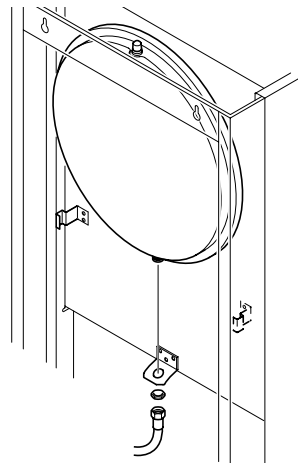

Diagram 27

Diagram 28

SCHEMATIC WIRING DIAGRAM

Following errors are displayed:

- F0 - loss of system water / pressure sensor failure
- F1 - no flame detected
- F2 - CH thermostat failure
- F3 - boiler overheating
- F4 - DHW thermostat failure

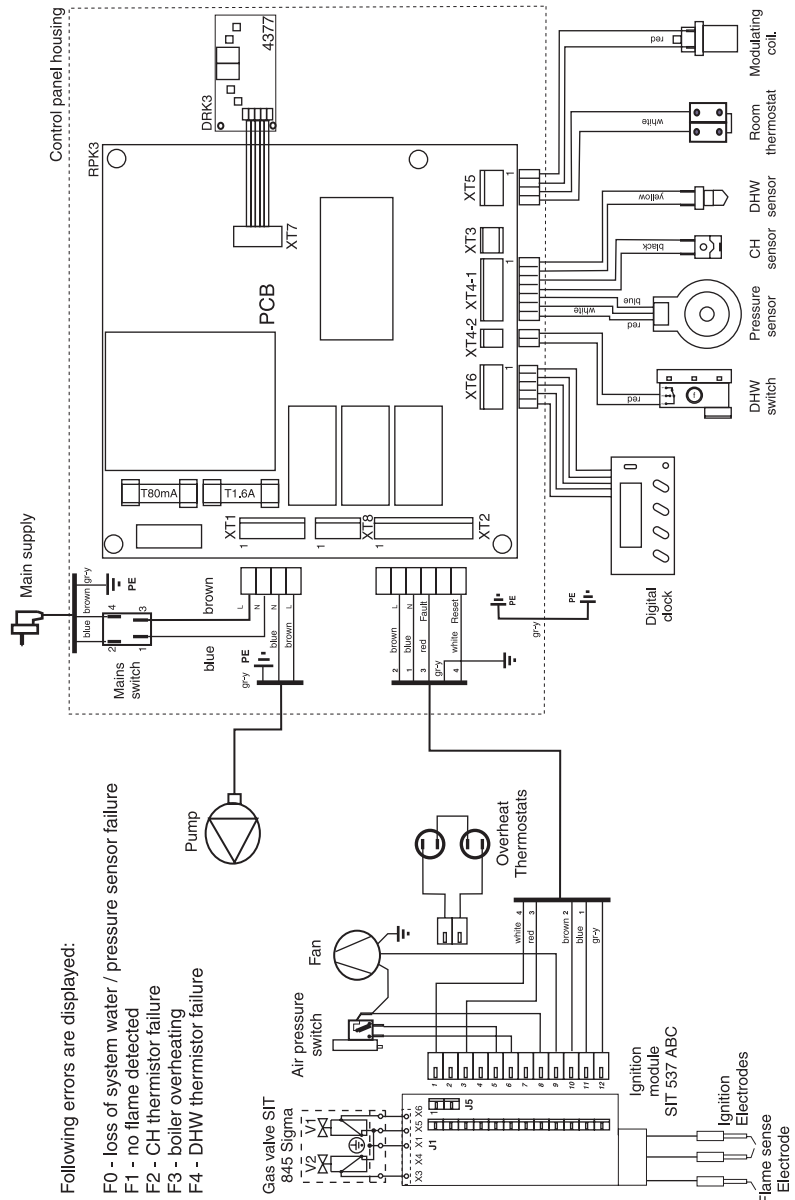

FAULT FINDING

Before fault finding, make sure that:

- All gas cocks are open and there is an inlet gas pressure of 20 mbar (G 20)
- The heating system pressure is at least 1 bar.
- There is a permanent mains supply to the boiler
- The fuses on the PCB are intact.
- All external controls are correctly wired and calling for heat.

WARNING: Always isolate the boiler from the electrical supply before carrying out any electrical replacement work. Always check for gas soundness after any service work.

Digital display shows:

- CH temperature (no decimal point displayed)
- DHW temperature (decimal point displayed)
- diagnostic error messages
- pressure in CH system
- boiler output setting

As soon as the mains switch is on the display shows for a very short time the version of software used. It has no importance for boiler operation.

Diagnostic error messages

In the event of a fault the following diagnostic error messages will be displayed:

Message	Fault	Action	Comments
F0	Loss of system water	Refill system Check for leaks	Pump runs for one minute. Boiler is restarted by switching of main switch.
	Air lock in boiler Pressure sensor failure	Bleed boiler and system Check the pressure sensor (Sensing inlet must not be clogged)	
F1	No flame detected	Check flame sense electrode and connecting cable Check ignition electrode Check ignition unit on gas valve Check fan operation	
	Overheating of the boiler	Reset overheat thermostats Check the pump revolution	If overheat Thermostats are blocked, boiler does not ignite when starting
F2	Central heating thermistor failure	Check if flow thermistor is not disconnected or short-circuited Sensor Ohm resistance 10 k Ω by 25°C, 12,7 k Ω by 20°C, 16 k Ω by 15°C	

CH water temperature below 3°C Check if system is not frozen

F3	Heat exchanger blockage	Check main heat exchanger Check domestic heat exchanger	Boiler shuts down and pump runs
F4	Domestic hot water thermistor faulty	Check thermistor/leads Sensor Ohm resistance: 10 kΩ by 25°C 12,7 kΩ by 20°C 16 kΩ by 15°C	Domestic hot water is available but poor

Air pressure switch failure:

If the fan and the pump is running but the boiler doesn't light, check the air pressure switch.

Blown fuses:

If the main switch is on and display does not light check the FUSE (1) T80mA, see diagram 22.

If the display lights but the pump, the fan and the ignition module don't work check the FUSE (2) T1.6A, see diagram 22.

Warning message:

If the pressure in CH system drops to 0.8 bar the LED on the Bar/MODE button starts to flash. This give you information that CH pressure is on the low limit and must be pressurised. Nevertheless the boiler works until the pressure drops to 0.6 bar – then boiler shuts down and F0 is displayed.

DHW flow is poor

If DHW flow is poor or boiler does not start when hot water tap is open, check following: Cold water supply pressure is at least 1 bar.

Check if the cold water filter or flow regulator (plastic 'O' ring) is not clogged.

JAGUAR – CONVERSION TO LPG

Note: Conversion must only be carried out by a qualified competent person

- Isolate boiler from the gas and electrical supplies.
- Remove boiler casing, sealed chamber and combustion chamber cover as described in Installation/Service Instructions.
- Disconnect flame sense electrode.
- Disconnect ignition lead at gas valve module.
- Disconnect ignition earth lead.
- Undo nut securing gas supply pipe between burner and gas valve.
- Undo two locking nuts (Jaguar 23) or unscrew 2 screws (Jaguar 28) securing burner to base of sealed chamber.
- Pull main burner up and forward out of boiler.

Note: The washer between the burner and burner gas supply must be kept to use in reassembly.

Jaguar 23

- Unscrew and remove two injector bars retaining screws and separate injector bar from burner.
- Fit new injector bar with marked diameter of injector → **0.68 mm** to the boiler in reverse order to removal.
- Readjust the gas valve.

Jaguar 28

- Fit new burner with marked diameter of injector → **0.73 mm** to the boiler in reverse order to removal.
- Readjust the gas valve.

Gas Valve Adjustment, refer to diagram 29.

To adjust the minimum and maximum settings, proceed as follows:

- Unlock the PCB box and swing it down
- Connect a manometer to the burner pressure test point (**b**) on the gas valve
- Remove the modulator plastic cap protecting the adjusting screw on the top of modulating coil
- Start the boiler in Domestic Hot Water mode to reach max. capacity (hot water tap fully open)
- Adjust the gas valve maximum pressure Pmax using nut (**1**) on the top of modulating coil. Turn the nut (**1**) fully clockwise by means of spanner No. 10 to reach Pmax (check on the manometer)
- Adjust the gas valve maximum pressure Pmin using red plastic screw on the top of modulating coil.
- Disconnect the connector from the modulating coil to assure that boiler will operate on minimum. Block the nut (**1**) in the fully clockwise position by means of spanner and by means of screwdriver turn the red plastic screw (**2**). Turn clockwise to increase, anti-clockwise to decrease. Check Pmin on the manometer.
- Connect the connector to modulating coil and check again the Pmax to be sure that nut (**1**) didn't move.
- Re-place the plastic cap cover on the modulator and disconnect manometer.
- Check for gas soundness.
- Check gas rate, refer to Commissioning (Gas pressures)
- Replace the PCB box and all covers.
- Stick the self-adhesive label (delivered with LPG conversion kit)

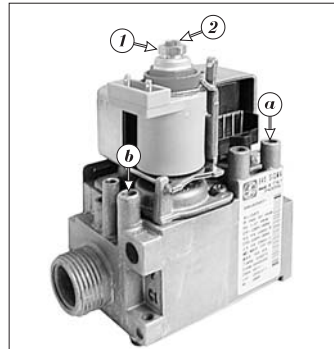

Diagram 29

Jaguar 23

G20 (20 mbar)	Inj. diam.	Pmin	Pmax
G31 (37 mbar)	1.07 mm	3 mbar	15.7 mbar
	0.68 mm	7.0 mbar	35.6 mbar

Jaguar 28

G20 (20 mbar)	Inj. diam.	Pmin	Pmax
G31 (36 mbar)	1.20 mm	2.5 mbar	14.0 mbar
	0.73 mm	4.9 mbar	36.0 mbar

Spare Parts

When ordering spare parts, quote the part number and description, stating the appliance model number and serial number from the data badge.

No.	Description	Part No.	G.C. No.
1	Air pressure switch	S99800749	●●●●●●
2	Automatic air vent	*****	●●●●●●
3	Burner G20	S92321160	●●●●●●
4	Burner injector G20	*****	●●●●●●
5	Controls thermostat	*****	●●●●●●
6	Central heating thermistor	*****	●●●●●●
7	Domestic hot water thermistor	*****	●●●●●●
8	Discharge safety valve	S93330028	●●●●●●
9	Domestic heat exchanger	S93311080	●●●●●●
10	Domestic water inlet filter	*****	●●●●●●
11	Display control board	S99800425	●●●●●●
12	Fan	S99801360	●●●●●●
13	Flame sense electrode	S91370037	●●●●●●
14	Gas control valve	S99800232	●●●●●●
15	Heat exchanger	S93312190	●●●●●●
16	Ignition electrode	S91370037	●●●●●●
17	Ignition and flame control unit	S99800233	●●●●●●
18	Modulating coil	*****	●●●●●●
19	Overheat thermostat	*****	●●●●●●
20	Printed circuit board (PCB)	S99800588	●●●●●●
21	Pump	S99800758	●●●●●●
22	Timeclock	S99800495	●●●●●●
23	Water flow sensor	S99800364	●●●●●●

**Please do not forget to complete
your
guarantee registration card.**

Supported by:

HEATCALL	<i>Customer Services:</i>
One Contact Local Service	<i>Tel: (01773) 525957</i>
	<i>Fax: (01773) 828070</i>

Because of our constant endeavour for improvement details may vary slightly from those in the instructions.

Jaguar

Nottingham Road
Belper, Derbyshire, DE56 1JT

Model: Serial No: Output kW:

Installation date: / / Installers name/address:
Installation Engineer:
.....
.....

ABOUT YOUR GUARANTEE

In order to register the guarantee of your new boiler, complete and send section 1 within 10 days of installation and retain section 2 for future reference.

**RETAIN THIS CARD FOR REFERENCE AND ENGINEERS USE NO DUPLICATE
WILL BE SUPPLIED**



Model: Jaguar Serial No: Output kW:

THIS CARD TO BE RETURNED WITHIN 10 DAYS OF INSTALLATION

USER
Name: **1** INSTALLER
Address: Installers name / address
.....
Postcode:
.....
Telephone No. Date: / /

**FREEPOST
JAGUAR REGISTRATION DEPARTMENT
NOTTINGHAM ROAD
BELPER
DERBYSHIRE
DE56 1JT**

GUARANTEE CONDITIONS

This appliance is guaranteed for a period of 12 months from the date of commissioning or 18 months from the date of despatch from our warehouse whichever is the shorter and covers manufacturing defects only.

The Manufacturer undertakes to repair or replace parts, free of charge, which are recognised by us to be of faulty manufacture, if necessary, after return to our factory for examination, on condition that:

- 1) The appliance was installed by a qualified gas installer in accordance with installation instructions, and all the relevant codes of practice, standards and legislation in force.
- 2) The appliance has been used for normal domestic purposes, and in accordance with The Manufacturers operating and maintenance instructions.
- 3) The appliance has not been serviced, maintained, repaired, dismantled or tampered with during the guarantee period by anyone other than an engineer approved by The Manufacturer.
- 4) The appliance is still in the possession of the original user and proof of purchase, in the form of a receipt or invoice, is shown to the service engineer on request.

The repair or replacement of parts during the guarantee period does not have the effect of extending the period.

This guarantee does not cover:

- a) Any defects or damage resulting from incorrect or poor installation, inadequate servicing or maladjustment of the gas or water used.
- b) Any defects in the system to which the appliance is connected.
- c) Any deterioration or maladjustment following changes in the nature or pressure of the gas or the water used, or a change in the characteristics of the electrical supply voltage.

Notification of any fault should be made to the appliance installer.

No repairs should be undertaken upon the appliance, intending it to be covered by the product guarantee without prior authorisation from The Manufacturer.

IMPORTANT: The appliance serial number must be quoted on all correspondence/contact made with The Manufacturer.

This guarantee is in addition to your statutory and other legal rights, which will not be excluded or diminished by the return of this card.

FOR SERVICE ENQUIRIES CONTACT:

**HEAT CALL
ON
01773 525957**